

User Manual

Hybrid 6KW/9KW INVERTER / CHARGER

Table Of Contents

ABOUT THIS MANUAL	1
Purpose.....	1
Scope.....	1
SAFETY INSTRUCTIONS.....	1
INTRODUCTION	2
Product Overview.....	3
INSTALLATION	4
Unpacking and Inspection.....	4
Preparation	4
Mounting the Unit.....	5
Battery Connection	5
AC Input/Output Connection.....	6
PV Connection	8
Communication Connection.....	9
Dry Contact Signal.....	9
OPERATION.....	10
Power ON/OFF	10
Operation and Display Panel	10
LCD Display Icons	11
LCD Setting.....	12
Display Setting	19
Operating Mode Description	23
SPECIFICATIONS.....	28
TROUBLE SHOOTING	29

ABOUT THIS MANUAL

Purpose

This manual describes the assembly, installation, operation and troubleshooting of this unit. Please read this manual carefully before installations and operations. Keep this manual for future reference.

Scope

This manual provides safety and installation guidelines as well as information on tools and wiring.

SAFETY INSTRUCTIONS



WARNING: This chapter contains important safety and operating instructions. Read and keep this manual for future reference.

1. Before using the unit, read all instructions and cautionary markings on the unit, the batteries and all appropriate sections of this manual.
2. **CAUTION** --To reduce risk of injury, charge only deep-cycle lead acid type rechargeable batteries. Other types of batteries may burst, causing personal injury and damage.
3. Do not disassemble the unit. Take it to a qualified service center when service or repair is required. Incorrect re-assembly may result in a risk of electric shock or fire.
4. To reduce risk of electric shock, disconnect all wirings before attempting any maintenance or cleaning. Turning off the unit will not reduce this risk.
5. **CAUTION** – Only qualified personnel can install this device with battery.
6. **NEVER** charge a frozen battery.
7. For optimum operation of this inverter/charger, please follow required spec to select appropriate cable size. It's very important to correctly operate this inverter/charger.
8. Be very cautious when working with metal tools on or around batteries. A potential risk exists to drop a tool to spark or short circuit batteries or other electrical parts and could cause an explosion.
9. Please strictly follow installation procedure when you want to disconnect AC or DC terminals. Please refer to INSTALLATION section of this manual for the details.
10. Fuses are provided as over-current protection for the battery supply.
11. GROUNDING INSTRUCTIONS -This inverter/charger should be connected to a permanent grounded wiring system. Be sure to comply with local requirements and regulation to install this inverter.
12. NEVER cause AC output and DC input short circuited. Do NOT connect to the mains when DC input short circuits.
13. **Warning!!** Only qualified service persons are able to service this device. If errors still persist after following troubleshooting table, please send this inverter/charger back to local dealer or service center for maintenance.

INTRODUCTION

This hybrid PV inverter can provide power to connected loads by utilizing PV power, utility power and battery power.

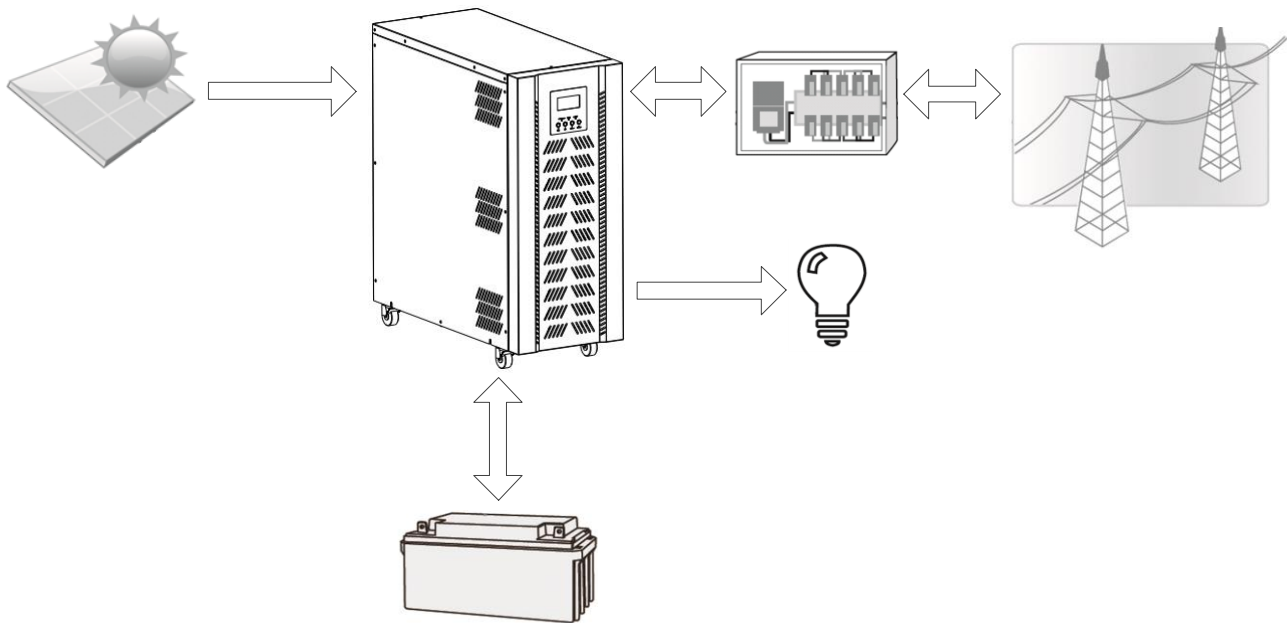
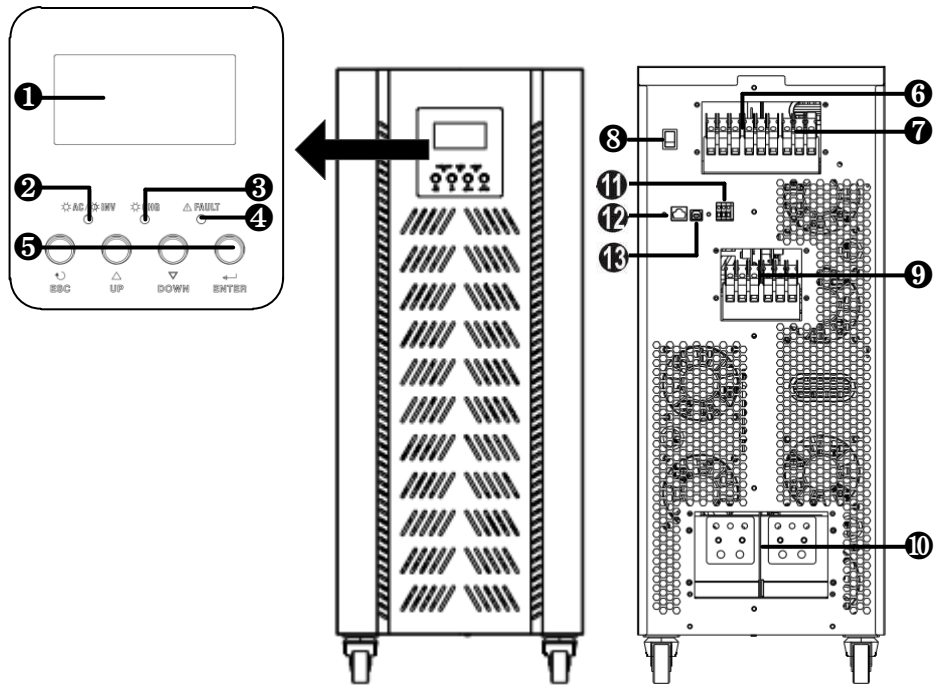

Figure 1 Basic hybrid PV System Overview

Depending on different power situations, this hybrid inverter is designed to generate continuous power from PV solar modules (solar panels), battery, and the utility. When MPP input voltage of PV modules is within acceptable range (see specification for the details), this inverter is able to generate power to feed the grid (utility) and charge battery. Galvanic isolation designed between PV/DC and AC output, so that user could connect any type of PV array to this Hybrid inverter. See Figure 1 for a simple diagram of a typical solar system with this hybrid inverter.

Product Overview



- | | |
|--|--|
| <ol style="list-style-type: none"> 1. LCD display 2. Status indicator 3. Charging indicator 4. Fault indicator 5. Function buttons 6. Grid connectors 7. AC output connectors (Load connection) 8. Power on/off switch | <ol style="list-style-type: none"> 9. PV connectors 10. Battery connectors 11. Dry contact 12. RS-232 communication port 13. USB communication port |
|--|--|

INSTALLATION

Unpacking and Inspection

Before installation, please inspect the unit. Be sure that nothing inside the package is damaged. You should have received the following items inside of package:

- The unit x 1
- User manual x 1
- Communication cable x 1
- Software CD x 1

Preparation

Before connecting all wirings, please take off three covers by removing 12 screws as shown in ①, ② and ③ below.

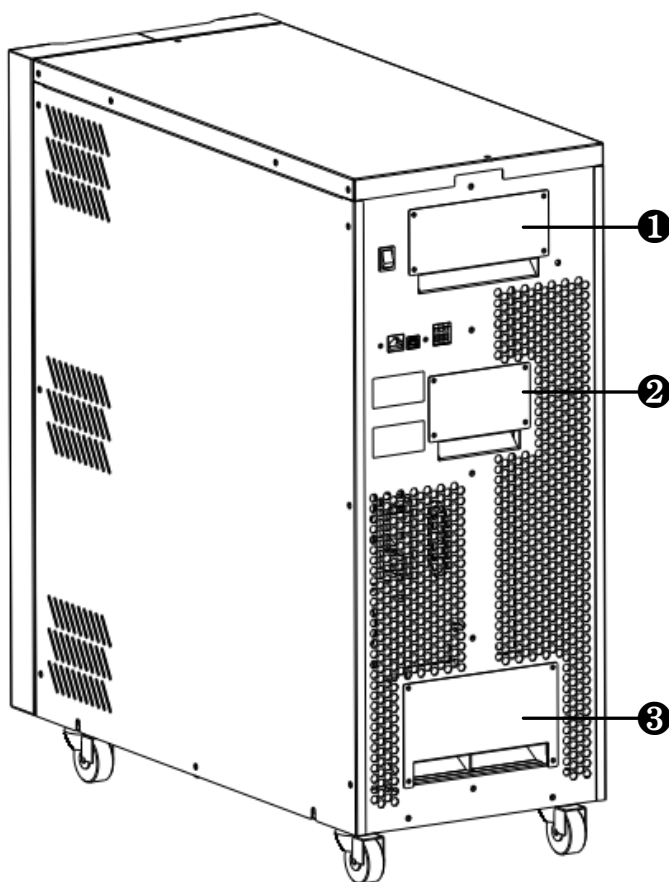

Location for the Unit

Consider the following points before selecting where to install:

- It's requested to have a clearance of approx. 80 cm to the front and back of the unit and approx. 50 cm to the side.
- Dusty conditions on the unit may impair the performance of this inverter.
- The ambient temperature should be between 0°C and 55°C to ensure optimal operation.
- For proper operation, please use appropriate cables.

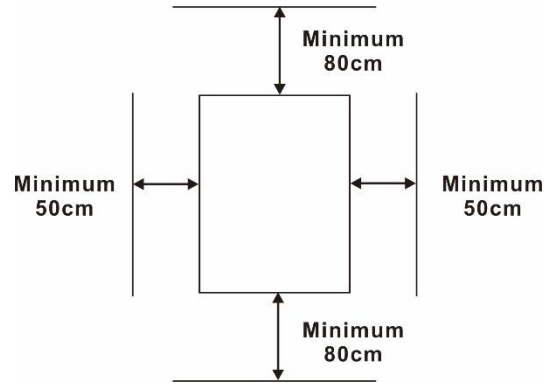

Battery Connection

CAUTION: For safety operation and regulation compliance, it's requested to install a separate DC over-current protector or disconnect device between battery and inverter. It may not be requested to have a disconnect device in some applications, however, it's still requested to have over-current protection installed. Please refer to typical amperage in below table as required fuse or breaker size.

WARNING! All wiring must be performed by a qualified personnel.

WARNING! It's very important for system safety and efficient operation to use appropriate cable for battery connection. To reduce risk of injury, please use the proper recommended cable and terminal size as below.

Ring terminal:

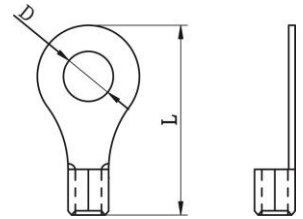

Recommended battery cable and terminal size:

Model	Typical Amperage	Battery Capacity	Cable Size	Ring Terminal			Torque Value
				Cable mm ²	Dimensions		
					D (mm)	L (mm)	
6KW	180A	600AH	2*4AWG	44	8.4	33.5	10~12 Nm
			1*1/0AWG	60	8.4	49.7	10~12 Nm
9KW	250A	600AH	2*2AWG	76	8.4	39.2	10~12 Nm

Please follow below steps to implement battery connection:

1. Assemble battery ring terminal based on recommended battery cable and terminal size.
2. Insert the ring terminal of battery cable flatly into battery connector of inverter and make sure the bolts are tightened with torque of 10-12 Nm. Make sure polarity at both the battery and the unit is correctly connected and ring terminals are tightly screwed to the battery terminals.

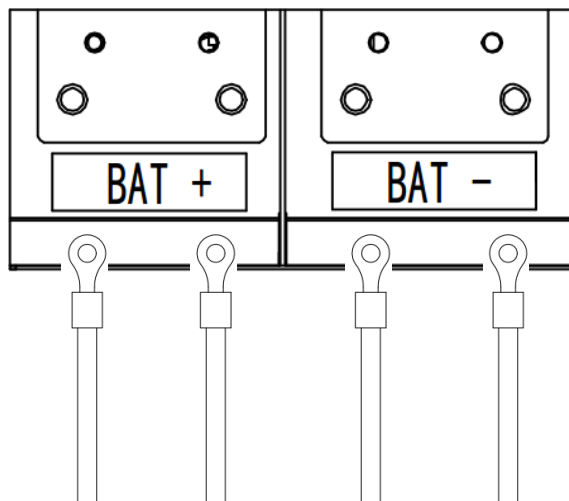

**WARNING: Shock Hazard**

Installation must be performed with care due to high battery voltage in series.

**CAUTION!!** Do not place anything between the flat part of the inverter terminal and the ring terminal. Otherwise, overheating may occur.**CAUTION!!** Do not apply anti-oxidant substance on the terminals before terminals are connected tightly.**CAUTION!!** Before making the final DC connection or closing DC breaker/disconnector, be sure positive (+) must be connected to positive (+) and negative (-) must be connected to negative (-).

AC Input/Output Connection

CAUTION!! Before connecting to AC input power source, please install a **separate** AC breaker between inverter and AC input power source. This will ensure the inverter can be securely disconnected during maintenance and fully protected from over current of AC input.**CAUTION!!** There are two terminal blocks with "IN" and "OUT" markings. Please do NOT mis-connect input and output connectors.**WARNING!** All wiring must be performed by a qualified personnel.**WARNING!** It's very important for system safety and efficient operation to use appropriate cable for AC input connection. To reduce risk of injury, please use the proper recommended cable size as below.**Suggested cable requirement for AC wires**

Model	Typical Amperage	Gauge	Torque Value
6KW	8.7A	14 AWG	1.4~ 1.6Nm
9KW	13A	12 AWG	1.4~ 1.6Nm

Please follow below steps to implement AC input/output connection:

1. Before making AC input/output connection, be sure to open DC protector or disconnector first.
2. Remove insulation sleeve 10mm for six conductors. And shorten phase L and neutral conductor N 3 mm.
3. Insert AC input wires according to polarities indicated on terminal block and tighten the terminal screws. Be sure to connect PE protective conductor (⊕) first.

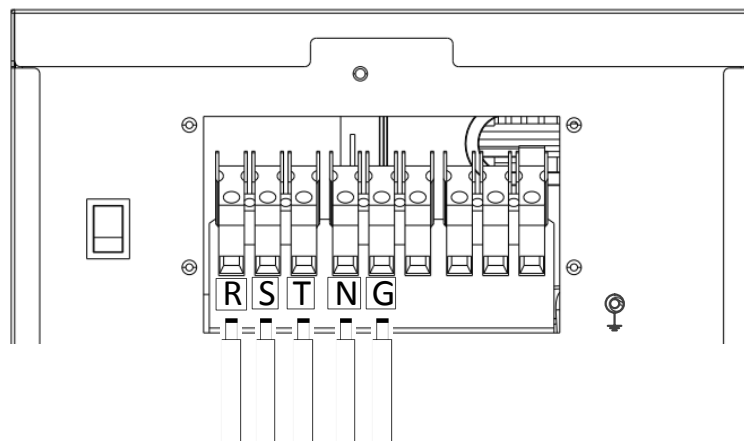
⊕→**Ground (yellow-green)****R→LINE (black)****S→LINE (gray)****T→LINE (brown)****N→Neutral (blue)**

**WARNING:**

Be sure that AC power source is disconnected before attempting to hardwire it to the unit.

4. Then, insert AC output wires according to polarities indicated on terminal block and tighten terminal screws.
Be sure to connect PE protective conductor (⊕) first.



→ **Ground (yellow-green)**

R→ **LINE (black)**

S→ **LINE (gray)**

T→ **LINE (brown)**

N→ **Neutral (blue)**

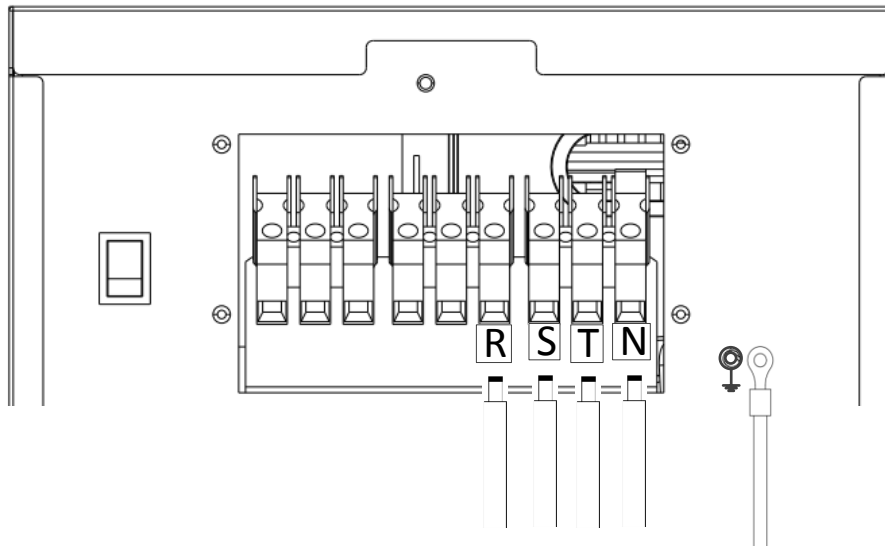

5. Make sure the wires are securely connected.

CAUTION: Appliances such as air conditioner are required at least 2~3 minutes to restart because it's required to have enough time to balance refrigerant gas inside of circuits. If a power shortage occurs and recovers in a short time, it will cause damage to your connected appliances. To prevent this kind of damage, please check manufacturer of air conditioner if it's equipped with time-delay function before installation. Otherwise, this inverter/charger will trig overload fault and cut off output to protect your appliance but sometimes it still causes internal damage to the air conditioner.

PV Connection

CAUTION: Before connecting to PV modules, please install separately a DC circuit breaker between inverter and PV modules.

WARNING! All wiring must be performed by a qualified personnel.

WARNING! It's very important for system safety and efficient operation to use appropriate cable for PV module connection. There are three MPP trackers and each tracker contains two terminals: positive (+) and negative (-). To reduce risk of injury, please use the proper recommended cable size as below.

Model	MPP Number	Typical Amperage	Cable Size	Torque Value
6KW	PV 1	13A	12AWG	2.0~2.4Nm
	PV 2	13A	12AWG	
	PV 3	13A	12AWG	
9KW	PV 1	18A	10AWG	2.0~2.4Nm
	PV 2	18A	10AWG	
	PV 3	18A	10AWG	

PV Module Selection:

When selecting proper PV modules, please be sure to consider below parameters:

1. Open circuit Voltage (Voc) of PV modules not exceeds max. PV array open circuit voltage of inverter.
2. Open circuit Voltage (Voc) of PV modules should be higher than min. battery voltage.

Solar Charging Mode		
INVERTER MODEL	6KW	9KW
Max. PV Array Open Circuit Voltage	450Vdc	
PV Array MPPT Voltage Range	120~430Vdc	
MPP Number	3	

Please follow below steps to implement PV module connection:

1. Remove insulation sleeve 3 mm for positive and negative conductors.
2. Check correct polarity of connection cable from PV modules and PV input connectors. Then, connect positive pole (+) of connection cable to positive pole (+) of PV input connector. Connect negative pole (-) of connection cable to negative pole (-) of PV input connector.

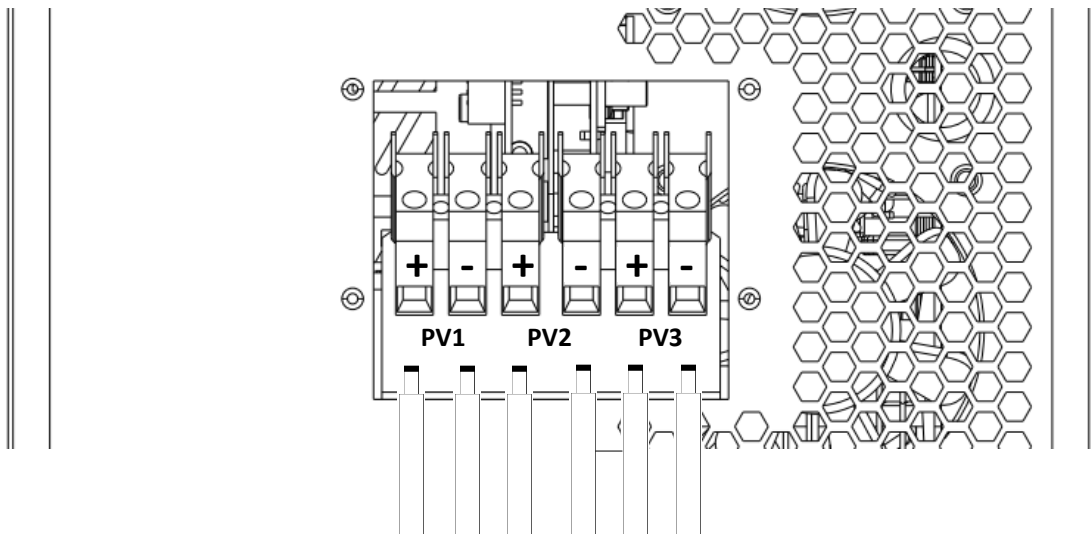
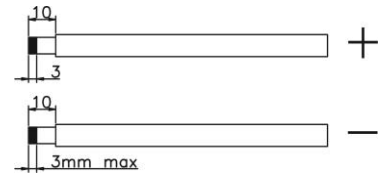

Recommended PV module specification

Maximum Power (Pmax)	250Wp
Max. Power Voltage Vmpp(V)	30.7Vdc
Max. Power Current Impp(A)	8.15A
Open Circuit Voltage Voc(V)	37.4Vdc
Short Circuit Current Isc(A)	8.63A

Recommended PV module Configuration

Combination #		PV 1		PV 2		PV 3		Q'ty of modules	
Model		6KW	9KW	6KW	9KW	6KW	9KW	6KW	9KW
1	PV module numbers in series	6	6	6	6	6	6	36pcs	36pcs
	PV module numbers in parallel	2	2	2	2	2	2		
2	PV module numbers in series	6	6	6	6	6	6	18pcs	18pcs
3	PV module numbers in series	8	8	8	8	8	8	24pcs	24pcs
4	PV module numbers in series	11	11	11	11	11	11	33pcs	33pcs
5	PV module numbers in series	/	8	/	8	/	8	/	48pcs
	PV module numbers in parallel	/	2	/	2	/	2	/	

Communication Connection

Please use supplied communication cable to connect to inverter and PC. Insert bundled CD into a computer and follow on-screen instruction to install the monitoring software. For the detailed software operation, please check user manual of software inside of CD.

Dry Contact Signal

There is one dry contact (3A/250VAC) available on the rear panel. It could be used to deliver signal to external device when battery voltage reaches warning level.

Unit Status	Condition			Dry contact port: 	
				NC & C	NO & C
Power Off	Unit is off and no output is powered.			Close	Open
Power On	Output is powered from Utility.			Close	Open
	Output is powered from Battery or Solar.	Program 01 set as SUB	Battery voltage < Low DC warning voltage	Open	Close
			Battery voltage > Setting value in Program 21 or battery charging reaches floating stage	Close	Open
	Output is powered from Battery or Solar.	Program 01 is set as SBU	Battery voltage < Setting value in Program 20	Open	Close
Battery voltage > Setting value in Program 21 or battery charging reaches floating stage			Close	Open	

OPERATION

Power ON/OFF

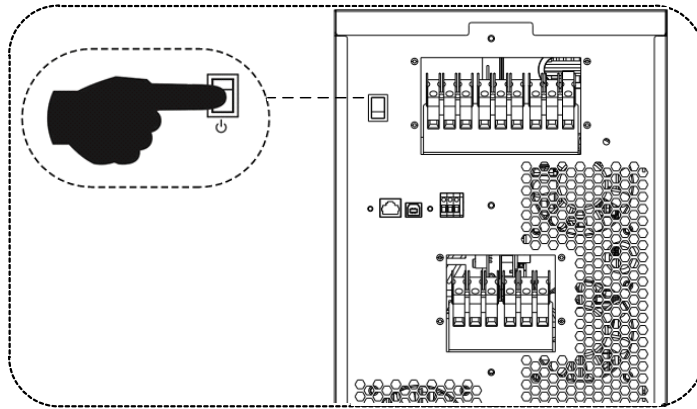

Once the unit has been properly installed and the batteries are connected well, simply press On/Off switch (located on the back panel of the unit) to turn on the unit.

Operation and Display Panel

The operation and display panel, shown in below chart, is on the front panel of the unit. It includes three indicators, four function keys and a LCD display, indicating the operating status and input/output power information.

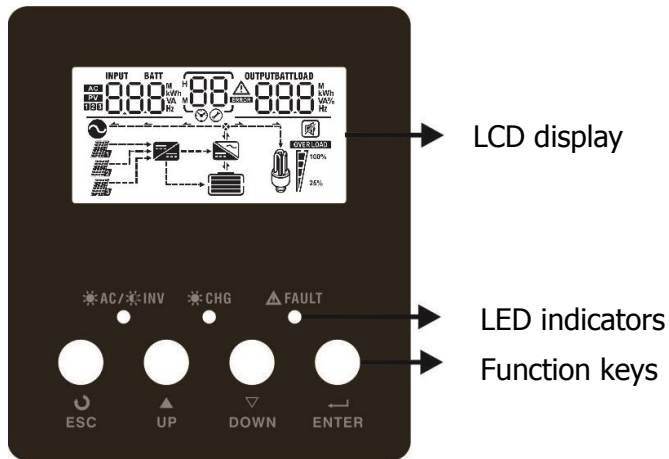

LED Indicator

LED Indicator		Messages	
☀ AC / 🌙 INV	Green	Solid On	Output is powered by utility in Line mode.
		Flashing	Output is powered by battery or PV in battery mode.
☀ CHG	Green	Solid On	Battery is fully charged.
		Flashing	Battery is charging.
⚠ FAULT	Red	Solid On	Fault occurs in the inverter.
		Flashing	Warning condition occurs in the inverter.





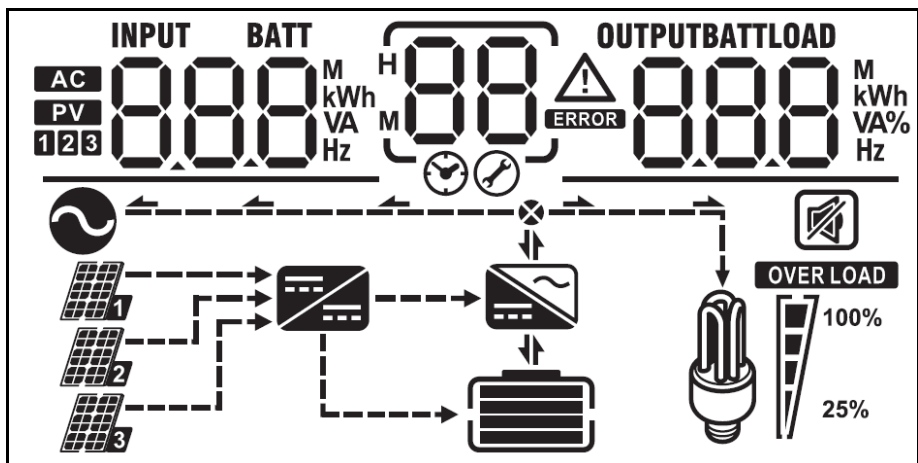

Function Keys

Function Key	Description
ESC	To exit setting mode
UP	To go to previous selection
DOWN	To go to next selection
ENTER	To confirm the selection in setting mode or enter setting mode

LCD Display Icons



Icon	Function								
Input Source Information									
	Indicates the AC input								
	Indicates the 1 st PV panel input								
	Indicates the 2 nd PV panel input								
	Indicates the 3 rd PV panel input								
	Indicate input voltage, input frequency, battery voltage, PV1 voltage, PV2 voltage, PV3 voltage and charger current								
Configuration Program and Fault Information									
	Indicates the setting programs.								
	Indicates the warning and fault codes. Warning: Flashing with warning code Fault: display with fault code								
Output Information									
	Indicate the output voltage, output frequency, load percent, load in VA, load in Watts, PV1 charger power, PV2 charger power, PV3 charger power and DC discharging current.								
Battery information									
	Indicates battery level by 0-24%, 25-49%, 50-74%, 75-100% and charging status.								
Load information									
	Indicates overload.								
	Indicates the load level by 0-24%, 25-49%, 50-74% and 75-100%.								
	<table border="1"> <tr> <td>0%~24%</td> <td>25%~49%</td> <td>50%~74%</td> <td>75%~100%</td> </tr> <tr> <td></td> <td></td> <td></td> <td></td> </tr> </table>	0%~24%	25%~49%	50%~74%	75%~100%				
0%~24%	25%~49%	50%~74%	75%~100%						











Mode operation information	
	Indicates unit connects to the mains.
	Indicates the unit connects to the 1 st string of PV panel
	Indicates the unit connects to the 2 nd string of PV panel
	Indicates the unit connects to the 3 rd string of PV panel
	Indicates the solar charger is working
	Indicates the DC/AC inverter circuit is working.
Mute operation	
	Indicates unit alarm is disabled.















LCD Setting

After pressing and holding ENTER button for 3 seconds, the unit will enter setting mode. Press "UP" or "DOWN" button to select setting programs. And then, press "ENTER" button to confirm the selection or ESC button to exit.







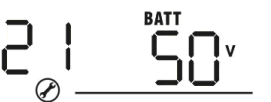

Program	Description	Selectable option	
00	Exit setting mode	Escape 00 ESC	
01	Output source priority selection	01 SUB	Solar energy provides power to the loads as first priority. If solar energy is not sufficient to power all connected loads, Utility energy will supply power to the loads at the same time.
		01 SBU	Solar energy provides power to the loads as first priority. If solar energy is not sufficient to power all connected loads, battery energy will supply power to the loads at the same time. Utility provides power to the loads only when battery voltage drops to either low-level warning voltage or the setting point in program 20 or solar and battery is not sufficient.
02	AC input voltage range	Appliances (default) 02 APL	If selected, acceptable AC input voltage range will be within 90-280VAC.





		UPS 02 UPS	If selected, acceptable AC input voltage range will be within 170-280VAC.
03	Output voltage	220Vac 03 220 ^v	230V (Default) 03 230 ^v
		240Vac 03 240 ^v	
04	Output frequency	50Hz (default) 04 50 ^{Hz}	60Hz 04 60 ^{Hz}
05	Solar supply priority	05 bLU	Solar energy provides power to charge battery as first priority.
		05 LbU	Solar energy provides power to the loads as first priority.
06	Overload bypass: When enabled, the unit will transfer to line mode if overload occurs in battery mode.	Bypass disable (default) 06 byd	Bypass enable 06 byE
07	Auto restart when overload occurs	Restart disable (default) 07 Lfd	Restart enable 07 LfE
08	Auto restart when over temperature occurs	Restart disable (default) 08 tfd	Restart enable 08 tFE
09	Solar or battery energy feed to grid configuration	09 Cfd	Solar or battery energy feed to grid disable.
		09 CfE	Solar or battery energy feed to grid enable.
10	Charger source priority: To configure charger source priority	If this inverter/charger is working in Line, Standby or Fault mode, charger source can be programmed as below:	
		Solar first 10 C50	Solar energy will charge battery as first priority. Utility will charge battery only when solar energy is not available.

		Solar and Utility (default) 	Solar energy and utility will charge battery at the same time.
		Only Solar 	Solar energy will be the only charger source no matter utility is available or not.
		If this inverter/charger is working in Battery mode or Power saving mode, only solar energy can charge battery. Solar energy will charge battery if it's available and sufficient.	
11	Maximum charging current: To configure total charging current for solar and utility chargers. (Max. charging current = utility charging current + solar charging current)	R phase default setting: 60A 	
		S phase default setting: 60A 	
		T phase default setting: 60A 	
		setting range is from 10A to 180A. Increment of each click is 10A.	
13	Maximum utility charging current	R phase default setting: 30A 	
		S phase default setting: 30A 	
		T phase default setting: 30A 	
		setting range is 2A , 10A , 20A , 30A , 40A , 50A and 60A.	
14	Battery type	AGM (default) 	Flooded 
		User-Defined 	If "User-Defined" is selected, battery charge voltage and low DC cut-off voltage can be set up in program 17, 18 and 19.

17	Bulk charging voltage (C.V voltage)	48V model default setting: 56.4V 	
		If self-defined is selected in program 14, this program can be set up. Setting range is from 48.0V to 64.0V . Increment of each click is 0.1V.	
18	Floating charging voltage	48V model default setting: 54.0V 	
		If self-defined is selected in program 14, this program can be set up. Setting range is from 48.0V to 64.0V. Increment of each click is 0.1V.	
19	Low DC cut off battery voltage setting	48V model default setting: 40.8V 	
		If self-defined is selected in program 14, this program can be set up. Setting range is from 40.8V to 48.0V. Increment of each click is 0.1V. Low DC cut-off voltage will be fixed to setting value no matter what percentage of load is connected.	
20	Battery stop discharging voltage when grid is available	44.0V 	45.0V 
		46.0V (default) 	47.0V 
		48.0V 	49.0V 
		50.0V 	51.0V 
21	Battery stop charging voltage when grid is available	Battery fully charged 	48.0V 
		49.0V 	50.0V 

		51.0V 21 ^{BATT} 51 ^v	52.0V 21 ^{BATT} 52 ^v
		53.0V 21 ^{BATT} 53 ^v	54.0V 21 ^{BATT} 54 ^v
21	Battery stop charging voltage when grid is available	55.0V 21 ^{BATT} 55 ^v	56.0V 21 ^{BATT} 56 ^v
		57.0V 21 ^{BATT} 57 ^v	58.0V 21 ^{BATT} 58 ^v
22	Auto return to default display screen	Return to default display screen (default) 22 ESP	If selected, no matter how users switch display screen, it will automatically return to default display screen (Input voltage /output voltage) after no button is pressed for 1 minute.
		Stay at latest screen 22 LEP	If selected, the display screen will stay at latest screen user finally switches.
23	Backlight control	Backlight on (default) 23 LON	Backlight off 23 LOF
24	Alarm control	Alarm on (default) 24 BON	Alarm off 24 BOF
25	Beeps while primary source is interrupted	Alarm on (default) 25 AON	Alarm off 25 AOF
27	Record Fault code	Record enable(default) 27 FEN	Record disable 27 FDS
29	Reset PV energy storage	Not reset(Default) 29 NRE	Reset 29 RSE

30	Start charging time for AC charger	<p>00:00 (Default)</p>  <p>The setting range of start charging time for AC charger is from 00:00 to 23:00, increment of each click is 1 hour.</p>	
31	Stop charging time for AC charger	<p>00:00 (Default)</p>  <p>The setting range of stop charging time for AC charger is from 00:00 to 23:00, increment of each click is 1 hour.</p>	
32	Scheduled time for AC output on	<p>00:00 (Default)</p>  <p>The setting range of scheduled Time for AC output on is from 00:00 to 23:00, increment of each click is 1 hour.</p>	
33	Scheduled time for AC output off	<p>00:00(Default)</p>  <p>The setting range of scheduled Time for AC output off is from 00:00 to 23:00, increment of each click is 1 hour.</p>	
34	Set country customized regulations	<p>India(Default)</p> 	<p>If selected, acceptable feed-in grid voltage range will be 195.5~253VAC. Acceptable feed-in grid frequency range will be 49~51Hz.</p>
		<p>Germany</p> 	<p>If selected, acceptable feed-in grid voltage range will be 184~264.5VAC. Acceptable feed-in grid frequency range will be 47.5~51.5Hz.</p>
		<p>South America</p> 	<p>If selected, acceptable feed-in grid voltage range will be 184~264.5VAC. Acceptable feed-in grid frequency range will be 57~62Hz.</p>
95	Time setting – Minute	 <p>For minute setting, the range is from 00 to 59.</p>	

96	Time setting – Hour	 <p>For hour setting, the range is from 00 to 23.</p>
97	Time setting– Day	 <p>For day setting, the range is from 00 to 31.</p>
98	Time setting– Month	 <p>For month setting, the range is from 01 to 12.</p>
99	Time setting – Year	 <p>For year setting, the range is from 16 to 99.</p>

Display Setting

The LCD display information will be switched in turns by pressing "UP" or "DOWN" key. The selectable information is switched as below order: input voltage, input frequency, PV voltage, charging current, battery voltage, output voltage, output frequency, load percentage, load in Watt, load in VA, load in Watt, DC discharging current, main board firmware version and SCC firmware version.

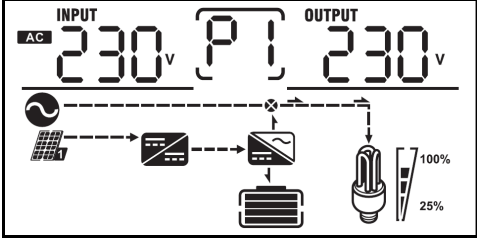
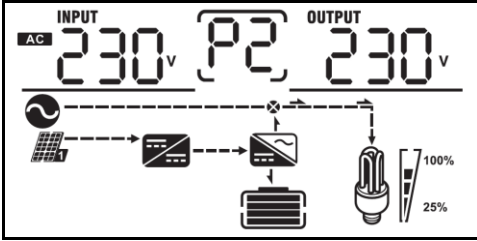
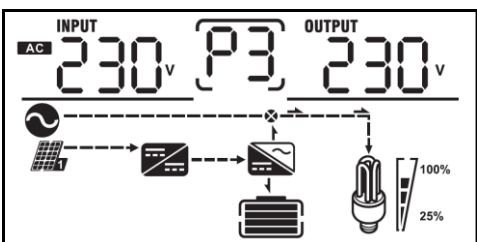
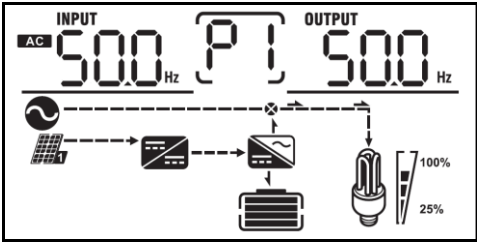
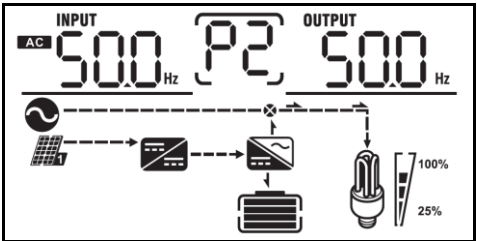
Select item	LCD display
Input voltage and output voltage (Default Display Screen)	R phase input Voltage=230V, output voltage=230V 
	S phase input Voltage=230V, output voltage=230V 
	T phase input Voltage=230V, output voltage=230V 
Input frequency and output frequency	R phase input frequency=50.0Hz, output frequency=50.0Hz 
	S phase input frequency=50.0Hz, output frequency=50.0Hz 
	T phase input frequency=50.0Hz, output frequency=50.0Hz

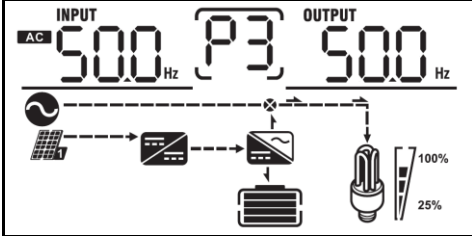
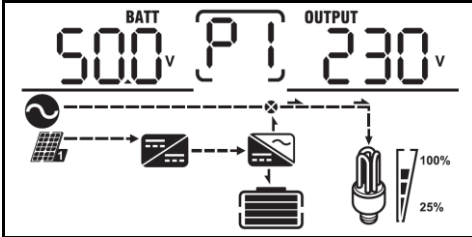
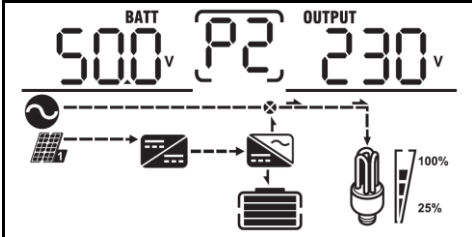
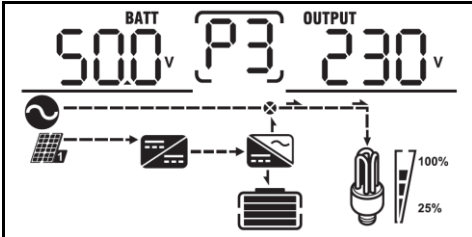
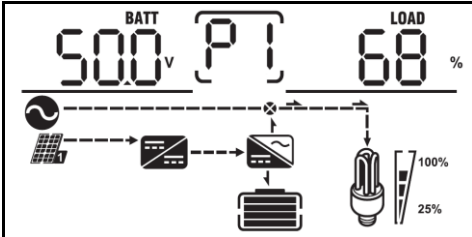
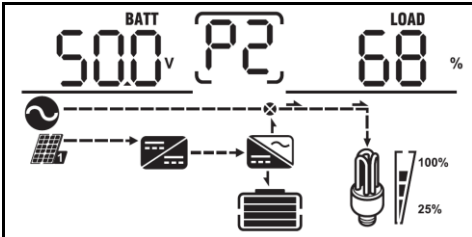
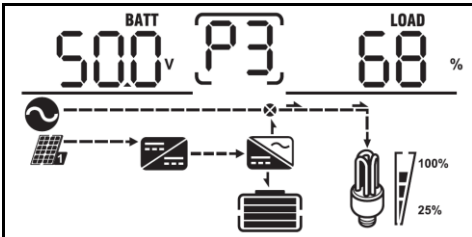

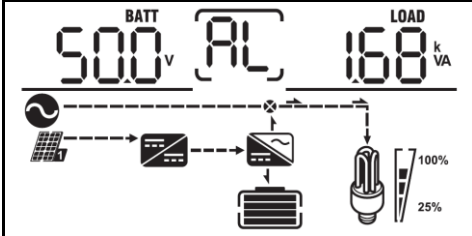
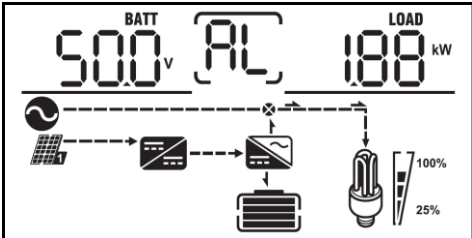
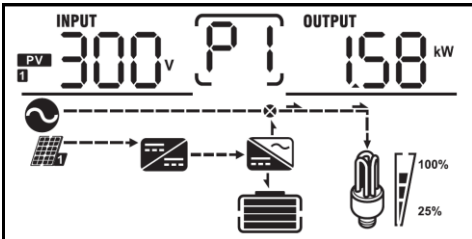
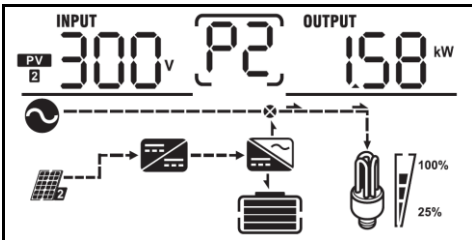
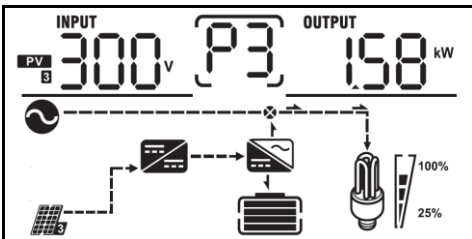
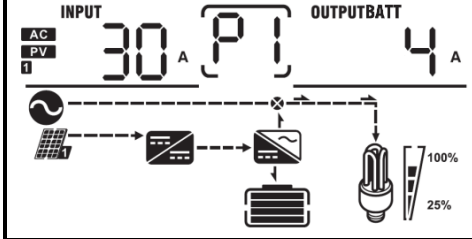
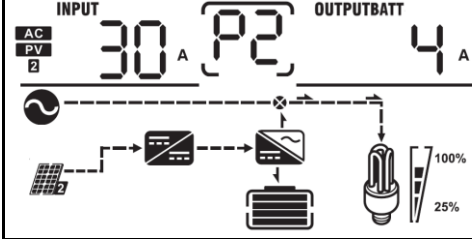

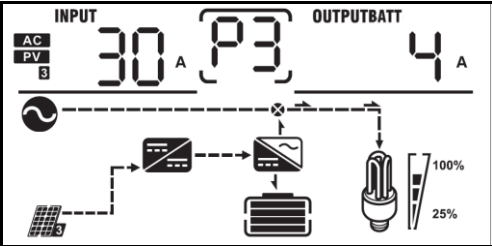
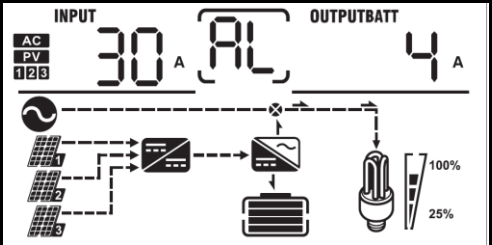
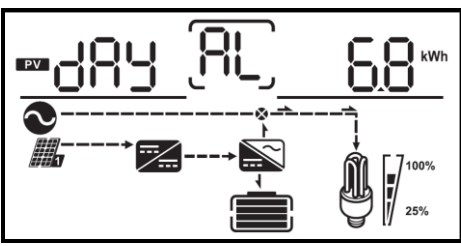
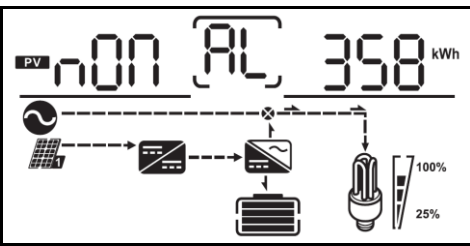
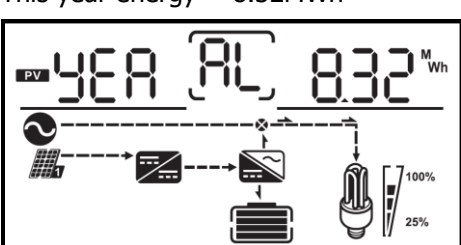
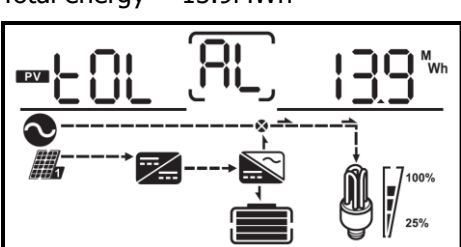
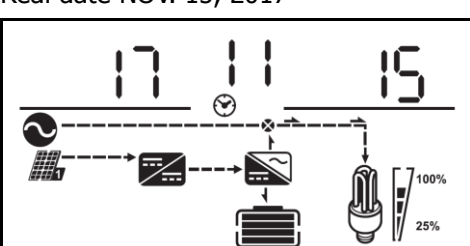
	
Battery voltage and output voltage	<p>R phase battery Voltage=50.0V, output voltage=230V</p>  <p>S phase battery Voltage=50.0V, output voltage=230V</p>  <p>T phase battery Voltage=50.0V, output voltage=230V</p> 
Battery voltage and load percentage	<p>R phase battery Voltage=50.0V, load percentage = 68%</p>  <p>S phase battery Voltage=50.0V, load percentage = 68%</p>  <p>T phase battery Voltage=50.0V, load percentage = 68%</p> 

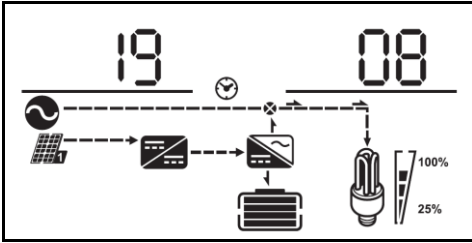
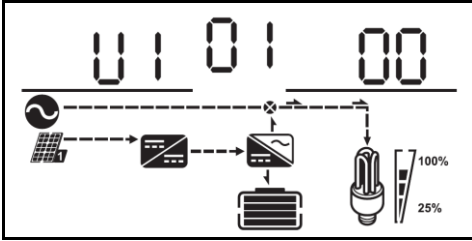
<p>Battery voltage and load in VA</p>	<p>Battery voltage=50.0V, total load in VA=1.68kVA</p> 
<p>Battery voltage and load in Watt</p>	<p>Battery voltage=50.0V, total load in Watt=1.88kW</p> 
<p>PV voltage and PV power</p>	<p>PV1 Voltage=300V, PV power=1.58kW</p> 
	<p>PV2 Voltage=300V, PV power=1.58kW</p> 
	<p>PV3 Voltage=300V, PV power=1.58kW</p> 
<p>Charger current and DC discharging current</p>	<p>Charging current in R phase =30A, discharging current=4A</p> 
	<p>Charging current in S phase =30A, discharging current=4A</p> 

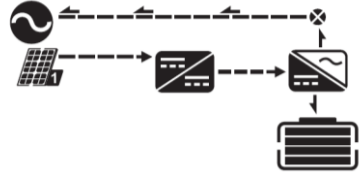

	<p>Charging current in T phase =30A, discharging current=4A</p> 
<p>Total charger current and total DC discharging current</p>	<p>charging current=30A, discharging current=4A</p> 
<p>PV energy generated today</p>	<p>Today energy = 6.8kWh</p> 
<p>PV energy generated this month</p>	<p>This month energy = 358kWh.</p> 
<p>PV energy generated this year</p>	<p>This year energy = 8.32MWh</p> 
<p>PV energy generated totally</p>	<p>Total energy = 13.9MWh</p> 
<p>Real date</p>	<p>Real date NOV. 15, 2017</p> 

Real time	Real time 19:08. 
Main board firmware version	Version 00001.00 



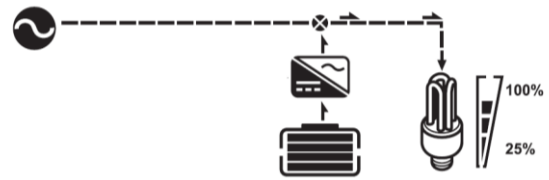
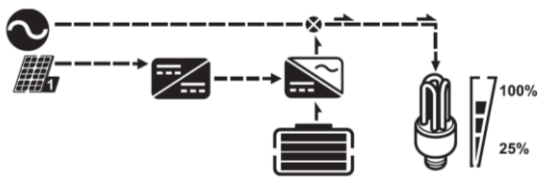
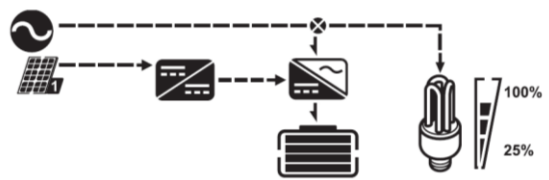
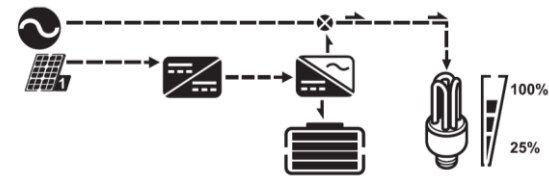
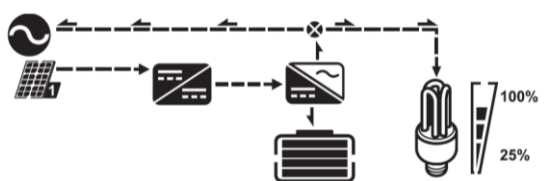
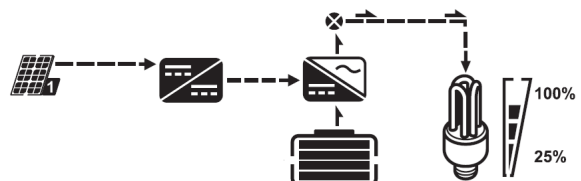

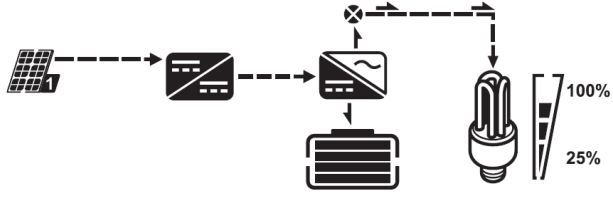
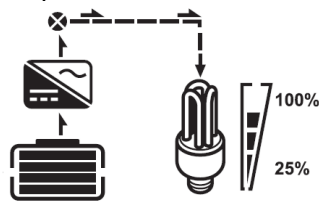
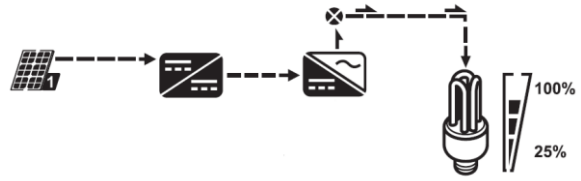



Operating Mode Description

Operating mode	Behaviors	LCD display
Standby mode Note: *Standby mode: The inverter is not turned on yet but at this time, the inverter can charge battery without AC output. *Power saving mode: If enabled, the output of inverter will be off when connected load is pretty low or not detected.	No output power, solar or utility charger available	Battery is charged by utility. 
		Battery is charged by PV energy. 
		Battery is charged by utility and PV energy. 
		Battery is charged by PV energy and feed PV energy to grid. 
		No charging. 



















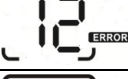

	<p>Output power from utility. Charger available</p>	<p>Utility charges battery and provides power to load.</p>  <p>Utility and battery power provide power to load.</p>  <p>PV energy, battery power and utility provide power to load.</p> 
<p>Line mode</p>	<p>Output power from utility. Charger available</p>	<p>PV energy and utility charge battery, and utility provides power to load.</p>  <p>PV energy charges battery, utility and PV energy provide power to the load.</p>  <p>PV energy charges battery, PV energy provides power to the load and feeds remaining energy to the grid.</p> 
<p>Battery mode</p>	<p>Output power from battery or PV</p>	<p>PV energy and battery energy supply power to the load.</p> 





		<p>PV energy charges battery and provides power to the load.</p> 
		<p>Battery provides power to the load.</p> 
Only PV mode	Output power from PV	<p>PV provides power to the load.</p> 
<p>Fault mode</p> <p>Note: *Fault mode: Errors are caused by inside circuit error or external reasons such as over temperature, output short circuited and so on.</p>	No output, no charging.	<p>No charging.</p> 

Warning Indicator

Warning Code	Warning Event	Icon flashing
01	Fan locked	
02	Over temperature	
03	Battery over charged	
04	Low battery	
07	Overload	
10	Output power derating	
15	PV weak	
19	Battery open	

Faults Reference Code

Fault Code	Fault Event	Icon on
01	Fan locked	
02	Over temperature	
03	Battery voltage is too high	
04	Battery voltage is too low	
05	Output short circuited	
06	Output voltage abnormal	
07	Over load time out	
08	Bus voltage is too high	
09	Bus soft start failed	
10	PV current over	
11	PV voltage over	
12	Charge current over	
51	Over current or surge	
52	Bus voltage is too low	
53	Inverter soft start failed	
55	Over DC offset in AC output	
56	Battery disconnected	
57	Current sensor failed	
58	Output voltage is too low	
60	Power feedback protection	
71	Internal firmware version inconsistent	
80	Internal CAN fault	

81	Internal host loss	
82	Internal synchronization loss	
83	Internal battery voltage detected different	
84	Internal AC input voltage and frequency detected different	
86	Internal AC output mode setting is different	

SPECIFICATIONS

MODEL	6KW	9KW
RATED OUTPUT POWER (per phase)	2000W	3000W
PV INPUT (DC)		
Max. PV Power (per MPP Tracker)	3000W	4000W
Max. PV Array Open Circuit Voltage	450VDC	
MPPT Range @ Operating Voltage	120 VDC~430 VDC	
Number of MPP Tracker	3	
GRID-TIE OPERATION		
GRID OUTPUT (AC) (per phase)		
Nominal Output Voltage	220/230/240 VAC	
Feed-in Grid Voltage Range	195.5~253 VAC @India regulation 184 ~ 264.5 VAC @Germany regulation	
Feed-in Grid Frequency Range	49~51Hz @India regulation 47.5~51.5Hz @Germany regulation	
Nominal Output Current	8.7A	13A
Power Factor Range	>0.99	
Maximum Conversion Efficiency (DC/AC)	95%	
OFF-GRID, HYBRID OPERATION (per phase)		
GRID INPUT		
Acceptable Input Voltage Range	90 - 280 VAC or 170 - 280 VAC	
Frequency Range	50 Hz/60 Hz (Auto sensing)	
Fuse	40A	
BATTERY MODE OUTPUT (AC) (per phase)		
Nominal Output Voltage	220/230/240 VAC	
Output Waveform	Pure Sine Wave	
Efficiency (DC to AC)	93%	
BATTERY & CHARGER		
Nominal DC Voltage	48 VDC	
Maximum Charging Current (from Grid)	60 A (per phase)	
Maximum Charging Current (from PV)	60 A (per MPP Tracker)	
Maximum Charging Current	180 A	
GENERAL		
Dimension, D X W X H (mm)	590 x 260 x 650	
Net Weight (kgs)	36	
INTERFACE		
Parallel-able	No	
External Safety Box (Optional)	No	
Communication	USB or RS232/Dry-Contact	
ENVIRONMENT		
Humidity	0 ~ 90% RH (No condensing)	
Operating Temperature	0 to 50°C	

TROUBLE SHOOTING

Problem	LCD/LED/Buzzer	Explanation / Possible cause	What to do
Unit shuts down automatically during startup process.	LCD/LEDs and buzzer will be active for 3 seconds and then complete off.	The battery voltage is too low (<1.91V/Cell)	1. Re-charge battery. 2. Replace battery.
No response after power on.	No indication.	1. The battery voltage is far too low. (<1.4V/Cell) 2. Battery polarity is connected reversed.	1. Check if batteries and the wiring are connected well. 2. Re-charge battery. 3. Replace battery.
Mains exist but the unit works in battery mode.	Input voltage is displayed as 0 on the LCD and green LED is flashing.	Input protector is tripped	Check if AC breaker is tripped and AC wiring is connected well.
	Green LED is flashing.	Insufficient quality of AC power. (Shore or Generator)	1. Check if AC wires are too thin and/or too long. 2. Check if generator (if applied) is working well or if input voltage range setting is correct. (UPS→Appliance)
	Green LED is flashing.	Set "Solar First" as the priority of output source.	Change output source priority to Utility first.
When the unit is turned on, internal relay is switched on and off repeatedly.	LCD display and LEDs are flashing	Battery is disconnected.	Check if battery wires are connected well.
Buzzer beeps continuously and red LED is on.	Fault code 07	Overload error. The inverter is overload 110% and time is up.	Reduce the connected load by switching off some equipment.
	Fault code 05	Output short circuited.	Check if wiring is connected well and remove abnormal load.
	Fault code 02	Internal temperature of inverter component is over 100°C.	Check whether the air flow of the unit is blocked or whether the ambient temperature is too high.
	Fault code 03	Battery is over-charged.	Return to repair center.
		The battery voltage is too high.	Check if spec and quantity of batteries are meet requirements.
	Fault code 01	Fan fault	Replace the fan.
	Fault code 06/58	Output abnormal (Inverter voltage is lower than 190Vac or higher than 260Vac)	1. Reduce the connected load. 2. Return to repair center
	Fault code 08/09/53/57	Internal components failed.	Return to repair center.
	Fault code 10	Surge	Restart the unit. If the error happens again, please return to repair center.
	Fault code 12	DC/DC over current or surge.	
	Fault code 51	Over current or surge.	
	Fault code 52	Bus voltage is too low.	
	Fault code 55	Output voltage is unbalanced.	
Fault code 56	Battery is not connected well or fuse is burnt.	If the battery is connected well but the problem remains, please return to repair center.	

Buzzer beeps continuously and red LED is on. Buzzer beeps continuously and red LED is on. Buzzer beeps continuously and red LED is on.	Fault code 60	Current feedback into the inverter is detected.	<ol style="list-style-type: none"> 1. Restart the inverter. 2. If the problem remains, please contact your installer.
	Fault code 71	Internal firmware version of each inverter is not the same.	<ol style="list-style-type: none"> 1. Restart the inverter. 2. If the problem remains, please contact your installer.
	Fault code 80	Internal CAN data loss	<ol style="list-style-type: none"> 1. Restart the inverter. 2. If the problem remains, please contact your installer.
	Fault code 81	Internal Host data loss	<ol style="list-style-type: none"> 1. Restart the inverter. 2. If the problem remains, please contact your installer.
	Fault code 82	Synchronization data loss	<ol style="list-style-type: none"> 1. Restart the inverter. 2. If the problem remains, please contact your installer.
	Fault code 83	The battery voltage of each inverter is not the same.	<ol style="list-style-type: none"> 1. Restart the inverter. 2. If the problem remains, please contact your installer.
	Fault code 84	AC input voltage and frequency are detected different.	<ol style="list-style-type: none"> 1. Restart the inverter. 2. If the problem remains, please contact your installer.
	Fault code 86	Internal AC output mode setting is different	<ol style="list-style-type: none"> 1. Restart the inverter. 2. If the problem remains, please contact your installer.