

USER'S MANUAL
SOLAR INVERTER/CHARGER

USER'S MANUAL
SOLAR INVERTER/CHARGER
PWM 1KVA- 5KVA

Appliances



PC



TV



Air-
conditioning



Fridge



Washing
machine

Table Of Contents

ABOUT THIS MANUAL	1
Purpose.....	1
Scope.....	1
SAFETY INSTRUCTIONS	1
INTRODUCTION	2
Features.....	2
Basic System Architecture.....	2
Product Overview.....	3
INSTALLATION	4
Unpacking and Inspection.....	4
Preparation.....	4
Mounting the Unit.....	4
Battery Connection.....	5
AC Input/Output Connection.....	7
PV Connection	8
Final Assembly.....	10
Communication Connection.....	10
Dry Contact Signal	11
OPERATION	12
Power ON/OFF.....	12
Operation and Display Panel.....	12
LCD Display Icons.....	13
LCD Setting.....	15
Fault Reference Code.....	21
Warning Indicator.....	23
Operating Mode Description.....	24
Display Setting.....	25
SPECIFICATIONS	26
Table 1 Line Mode Specifications.....	26
Table 2 Invert Mode Specifications.....	27
Table 3 Charge Mode Specifications.....	28
Table 4 General Specifications.....	29
TROUBLE SHOOTING	30
Appendix: Approximate Back-up Time Table	31

ABOUT THIS MANUAL

Purpose

This manual describes the assembly, installation, operation and troubleshooting of this unit. Please read this manual carefully before installations and operations. Keep this manual for future reference.

Scope

This manual provides safety and installation guidelines as well as information on tools and wiring.

SAFETY INSTRUCTIONS



WARNING: This chapter contains important safety and operating instructions. Read and keep this manual for future reference.

1. Before using the unit, read all instructions and cautionary markings on the unit, the batteries and all appropriate sections of this manual.
2. **CAUTION** --To reduce risk of injury, charge only deep-cycle lead acid type rechargeable batteries. Other types of batteries may burst, causing personal injury and damage.
3. Do not disassemble the unit. Take it to a qualified service center when service or repair is required. Incorrect re-assembly may result in a risk of electric shock or fire.
4. To reduce risk of electric shock, disconnect all wirings before attempting any maintenance or cleaning. Turning off the unit will not reduce this risk.
5. **CAUTION** – Only qualified personnel can install this device with battery.
6. **NEVER** charge a frozen battery.
7. For optimum operation of this inverter/charger, please follow required spec to select appropriate cable size. It's very important to correctly operate this inverter/charger.
8. Be very cautious when working with metal tools on or around batteries. A potential risk exists to drop a tool to spark or short circuit batteries or other electrical parts and could cause an explosion.
9. Please strictly follow installation procedure when you want to disconnect AC or DC terminals. Please refer to INSTALLATION section of this manual for the details.
10. Fuses (3 pieces of 40A, 32VDC for 1KVA ,4 pieces of 40A, 32VDC for 2KVA and 6pcs of that for 3KVA, 1 piece of 200A, 58VDC for 4KVA and 5KVA) are provided as over-current protection for the battery supply.
11. **GROUNDING INSTRUCTIONS** -This inverter/charger should be connected to a permanent grounded wiring system. Be sure to comply with local requirements and regulation to install this inverter.
12. **NEVER** cause AC output and DC input short circuited. Do NOT connect to the mains when DC input short circuits.
13. **Warning!!** Only qualified service persons are able to service this device. If errors still persist after following troubleshooting table, please send this inverter/charger back to local dealer or service center for maintenance.

INTRODUCTION

This is a multi-function inverter/charger, combining functions of inverter, solar charger and battery charger to offer uninterruptible power support with portable size. Its comprehensive LCD display offers user-configurable and easy-accessible button operation such as battery charging current, AC/solar charger priority, and acceptable input voltage based on different applications.

Features

- Pure sine wave inverter
- Configurable input voltage range for home appliances and personal computers via LCD setting
- Configurable battery charging current based on applications via LCD setting
- Configurable AC/Solar Charger priority via LCD setting
- Compatible to mains voltage or generator power
- Auto restart while AC is recovering
- Overload/ Over temperature/ short circuit protection
- Smart battery charger design for optimized battery performance
- Cold start function

Basic System Architecture

The following illustration shows basic application for this inverter/charger. It also includes following devices to have a complete running system:

- Generator or Utility.
- PV modules (option)

Consult with your system integrator for other possible system architectures depending on your requirements.

This inverter can power all kinds of appliances in home or office environment, including motor-type appliances such as tube light, fan, refrigerator and air conditioner.

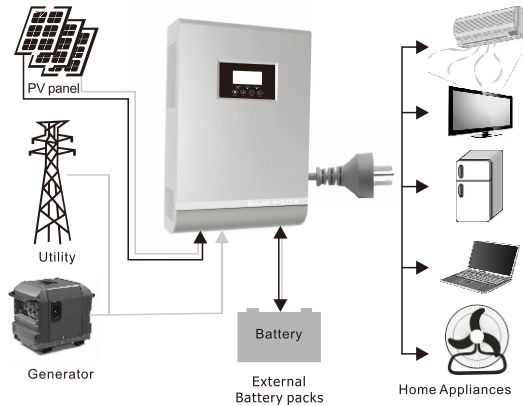
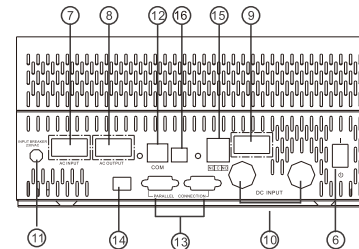
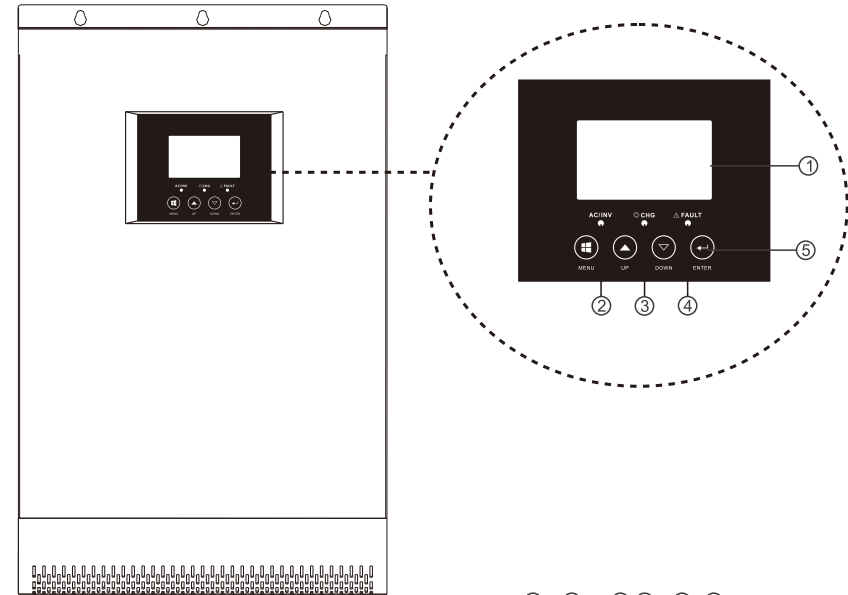

Figure 1 Hybrid Power System

Note: Appliances such as air conditioner are required at least 2~3 minutes to restart because it's required to have enough time to balance refrigerant gas inside of circuits. If a power shortage occurs and recovers in a short time, it will cause damage to your connected appliances. To prevent this kind of damage, please check manufacturer of air conditioner if it's equipped with time-delay function before installation. Otherwise, this inverter/charger will trig overload fault and cut off output to protect your appliance but sometimes it still causes internal damage to the air conditioner.

Product Overview



4KVA-5KVA parallel model

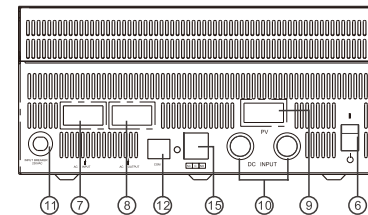

1KVA-3KVA single model

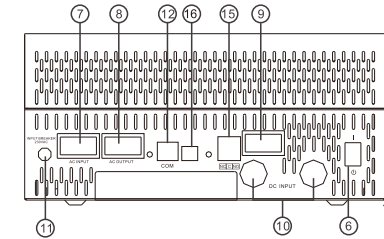

4KVA-5KVA single model

- 1.LCD display
- 2.Status indicator
- 3.Discharging/Charging indicator
- 4.Fault indicator
- 5.Function buttons
- 6.Power on/off switch
- 7.AC input
- 8.AC output
- 9.PV input
- 10.Battery input
- 11.Circuit breaker
- 12.RS-485 communication port
- 13.Parallel communication port
(only for parallel model)
- 14.Parallel switch
- 15.Dry contact
- 16.USB

NOTE: For parallel model installation and Operation ,please check separate parallel installation guide for the details.

INSTALLATION

Unpacking and Inspection

Before installation, please inspect the unit. Be sure that nothing inside the package is damaged. You should have received the following items inside of package:

- The unit x 1
- User manual x 1
- Communication cable x 1
- Software CD X 1

Preparation

Before connecting all wirings, please take off bottom cover by removing two screws as shown below.

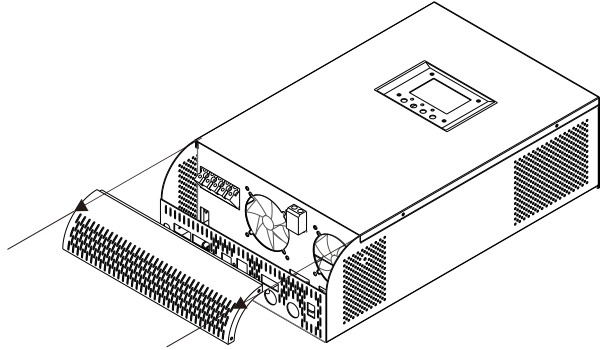

Mounting the Unit

Consider the following points before selecting where to install:

- Do not mount the inverter on flammable construction materials.
- Mount on a solid surface
- Install this inverter at eye level in order to allow the LCD display to be read at all times.
- For proper air circulation to dissipate heat, allow a clearance of approx. 200 mm to the side and approx. 300 mm above and below the unit.
- The ambient temperature should be between 0°C and 55°C to ensure optimal operation.
- The recommended installation position is to be adhered to the wall vertically.
- Be sure keep other objects and surfaces as shown in the below diagram to guarantee sufficient heat dissipation and to have enough space for removing wires.

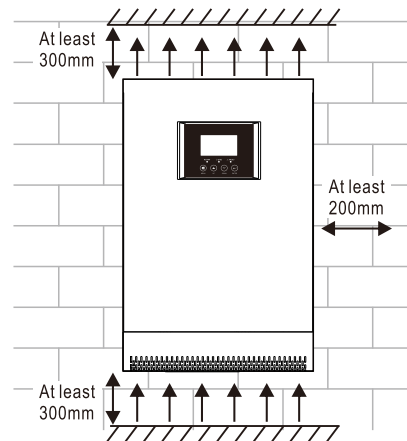

SUITABLE FOR MOUNTING ON CONCRETE OR OTHER NON-COMBUSTIBLE SURFACE ONLY.

Install the unit by screwing three screws.

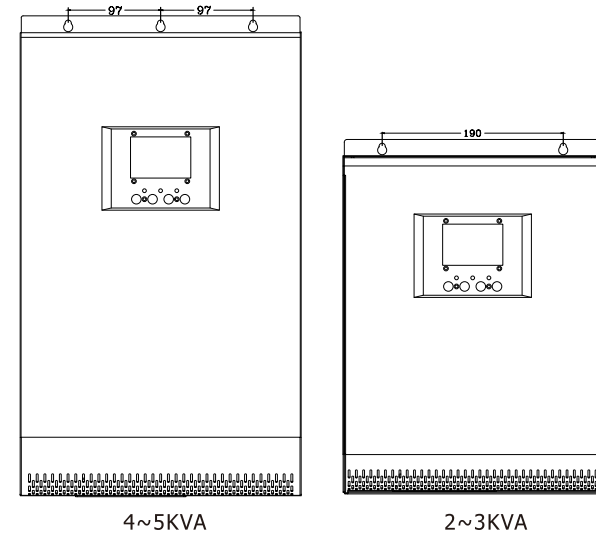

Battery Connection

CAUTION: To safety operation and regulation compliance, it's requested to install a separate DC over-current protector or disconnect device between battery and inverter. It may not be requested to have a disconnect device in some applications, however, it's still requested to have over-current protection installed. Please refer to typical amperage in below table as required fuse or beaker size.

WARNING! All wiring must be performed by a qualified personnel.

WARNING! It's very important for system safety and efficient operation to use appropriate cable for battery connection. To reduce risk of injury, please use the proper recommended cable and terminal size as below.

Recommended battery cable and terminal size:

Ring terminal:

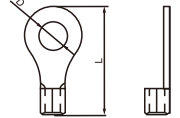

Model	Typical Amperage	Battery capacity	Wire Size	Ring Terminal			Torque value
				Cable mm ²	Dimensions		
					D(mm)	L(mm)	
1KVA/2KVA	66A	100AH	1*6AWG	14	6.4	29.2	2~ 3 Nm
		200AH	2*10AWG	8	6.4	23.8	2~ 3 Nm
3KVA	100A	100AH	1*4AWG	22	6.4	33.2	2~ 3 Nm
		200AH	2*8AWG	14	6.4	29.2	2~ 3 Nm
4KVA	66A	200AH	1*4AWG	22	6.4	33.2	2~ 3 Nm
			2*8AWG	14	6.4	29.2	2~ 3 Nm
5KVA	87A	200AH	1*4AWG	22	6.4	33.2	2~ 3 Nm
			2*8AWG	14	6.4	29.2	2~ 3 Nm

Please follow below steps to implement battery connection:

1. Assemble battery ring terminal based on recommended battery cable and terminal size.
2. 1KVA model supports 12VDC system, 2KVA/3KVA model support 24VDC system and 4KVA/5KVA model supports 48VDC system. Connect all battery packs as below chart, It's suggested to connect at least 100Ah capacity battery 1-3KVA model and at least 200Ah capacity battery for 4KVA/5KVA model.

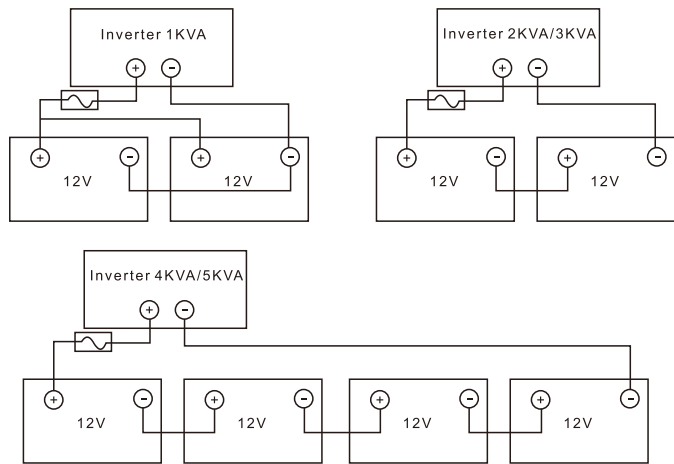

NOTE: Please only use sealed lead acid battery or sealed GEL/AGM/LI

3. Insert the ring terminal of battery cable flatly into battery connector of inverter and make sure the bolts are tightened with torque of 2-3 Nm. Make sure polarity at both the battery and the inverter /charge is correctly connected and ring terminals are tightly screwed to the battery terminals.

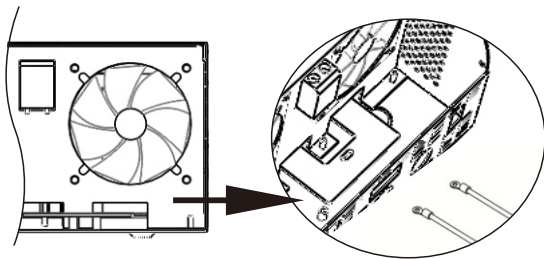

WARNING: Shock Hazard

Installation must be performed with care due to high battery voltage in series.



CAUTION!! Do not place anything between the flat part of the inverter terminal and the ring terminal. Otherwise, overheating may occur.

CAUTION!! Do not apply anti-oxidant substance on the terminals before terminals are connected tightly.

CAUTION!! Before making the final DC connection or closing DC breaker/disconnector, be sure DC (+) must be connected to DC (+) and DC (-) must be connected to DC (-).

AC Input/Output Connection

CAUTION!! Before connecting to AC input power source, please install a separate AC breaker between inverter and AC input power source. This will ensure the inverter can be securely disconnected during maintenance and fully protected from over current of AC input. The recommended spec of AC breaker is 10A for 1KVA, 20A for 2KVA, 32A for 3KVA, 40A for 4KVA and 50A for 5KVA.

CAUTION!! There are two terminal blocks with "IN" and "OUT" markings. Please do NOT mis-connect Input and output connectors.

WARNING! All wiring must be performed by a qualified personnel.

WARNING! It's very important for system safety and efficient operation to use appropriate cable for AC input connection. To reduce risk of injury, please use the proper recommended cable size as below.

Suggested cable requirement for AC wires

Model	Gauge	Torque Value
1KVA	16AWG	0.5~0.6Nm
2KVA	14AWG	0.8~1.0Nm
3KVA	12AWG	1.2~1.6Nm
4KVA	10AWG	1.4~1.6Nm
5KVA	8AWG	1.4~1.6Nm

Please follow below steps to implement AC input/output connection:

1. Before making AC input/output connection, be sure to open DC protector or disconnecter first.
2. Remove insulation sleeve 10mm for six conductors. And shorten phase L and neutral conductor N 3 mm.
3. Insert AC input wires according to polarities indicated on terminal block and tighten the terminal screws. Be sure to connect PE protective conductor (⊕) first.
 - ⊕ → Ground (yellow-green)
 - L → LINE (brown or black)
 - N → Neutral (blue)

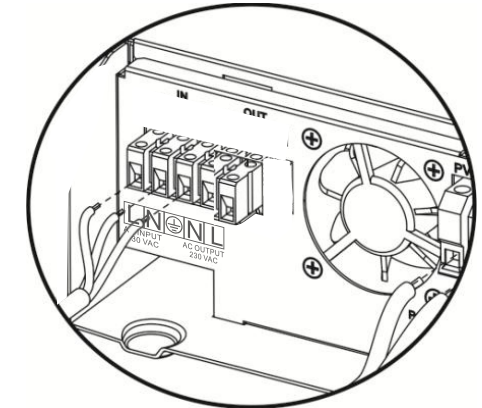

1KVA~5KVA



WARNING:

Be sure that AC power source is disconnected before attempting to hardware it to the unit.

4. Then, insert AC output wires according to polarities indicated on terminal block and tighten terminal screws. Be sure to connect PE protective conductor (⊕) first.

- ⊕ → Ground (yellow-green)
- L → LINE (brown or black)
- N → Neutral (blue)

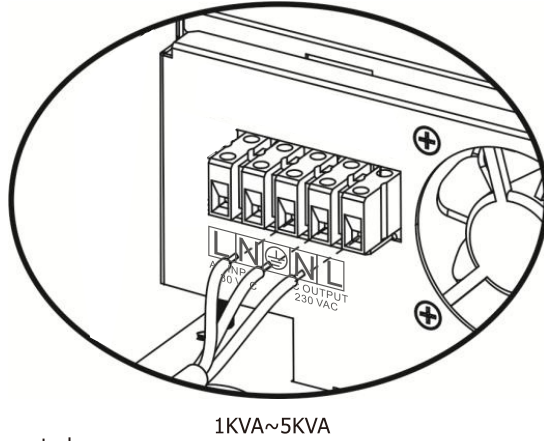

5. Make sure the wires are securely connected.

CAUTION: Important

Be sure connect AC wires with correct polarity. If L and N wires are connected reversely, it may cause utility short-circuited when these inverters are worked in parallel operation.

PV Connection (Only apply for the model with solar charger)

CAUTION: Before connecting to PV modules, please install separately a DC circuit breaker between inverter and PV modules.

WARNING! All wiring must be performed by a qualified personnel.

WARNING! It's very important for system safety and efficient operation to use appropriate cable for PV module connection. To reduce risk of injury, please use the proper recommended cable size as below.

Typical Amperage	Gauge	Torque Value
50A	8AWG	1.4~1.6Nm

PV Module Selection:

When selecting proper PV modules, please be sure to consider below requirements first:

1. Open circuit Voltage (Voc) of PV modules not exceeds max. PV array open circuit voltage of inverter

INVERTER MODEL	1KVA	2KVA	3KVA	4KVA	5KVA
Solar Charger					
Charging Current (PWM)	50Amp				
System DC Voltage	12Vdc	24Vdc		48Vdc	
Operating Voltage Range	15~18Vdc	30~32Vdc		60~72Vdc	
Max. PV Array Open Circuit Voltage	30Vdc	75Vdc		105Vdc	

2. Max. Power Voltage (Vmpp) of PV modules should be close to best Vmp of inverter or within Vmp range to get best performance. If one PV module can not meet this requirement, it's necessary to have several PV modules in series connection. Refer to below table.

Model	Best Vmp	Vmp range
1KVA	15Vdc	15~18Vdc
2KVA/3KVA	30Vdc	30~32Vdc
4KVA/5KVA	60Vdc	56~72Vdc

Note:* Vmp: panel max power point voltage.

The PV charging efficiency is maximized while PV system voltage is close to Best Vmp.

Maximum PV module numbers in Series: Vmpp of PV module* X pcs = Best Vmp of Inverter or Vmp range

PV module numbers in Parallel: Max. charging current of inverter/Imp

Total PV module numbers=maximum PV module numbers in series*PV module numbers in parallel

Take 1KVA inverter as an example to select proper PV modules. After considering Voc of PV module not exceeds 30Vdc and max. Vmpp of PV module close to 15Vdc or within 15Vdc~18Vdc, we can choose PV module with below specification.

Maximum Power (Pmaxl)	85W	Max. PV module numbers in series 1→17.6 x 1 =15~18
Max. Power Voltage Vmpp(V)	17.6V	
Max. Power Current Imp(A)	4.83A	PV module numbers in parallel 10→ 50 A/4.83 Total PV module numbers 1x10=10
Open Circuit Voltage Voc(V)	21.6V	
Short Circuit Current Isc(A)	5.03A	

Maximum PV module numbers in Series: 1

PV module numbers in Parallel: 10

Total PV module numbers: 1 x 10=10

Take 2K/3KVA inverter as an example to select proper PV module. After considering Voc of PV module not exceed 75Vdc and max. Vmpp of PV module close to 30Vdc or within 30Vdc~32Vdc, we can choose PV module with below specification.

Maximum Power (Pmaxl)	260W	Max. PV module numbers in series 1→30.9 x 1 =30~32
Max. Power Voltage Vmpp(V)	30.9V	
Max. Power Current Imp(A)	8.42A	PV module numbers in parallel 10→ 50 A/8.42 Total PV module numbers 1x6=6
Open Circuit Voltage Voc(V)	37.7V	
Short Circuit Current Isc(A)	8.89A	

Maximum PV module numbers in Series: 1

PV module numbers in Parallel: 6

Total PV module numbers: 1 x 6=6

Take 4K/5K model inverter as an example to select proper PV module, After considering Voc of PV module not exceed 105Vdc and max. Vmpp of PV module close to 60Vdc or within 56Vdc~72Vdc, we can choose PV module with below specification.

Maximum Power (Pmaxl)	260W	Max. PV module numbers in series 2→30.9 x 2 =56~72
Max. Power Voltage Vmpp(V)	30.9V	
Max. Power Current Imp(A)	8.42A	PV module numbers in parallel 6→ 50 A/8.42 Total PV module numbers 2x6=6
Open Circuit Voltage Voc(V)	37.7V	
Short Circuit Current Isc(A)	8.89A	

Maximum PV module numbers in Series: 2

PV module numbers in Parallel: 6

Total PV module numbers: 2 x 6=12

Please follow below steps to implement PV module connection:

1. Remove insulation sleeve 10 mm for positive and negative conductors.
2. Check correct polarity of connection cable from PV modules and PV input connectors. Then, connect positive pole (+) of connection cable to positive pole (+) of PV input connector. Connect negative pole (-) of connection cable to negative pole (-) of PV input connector.

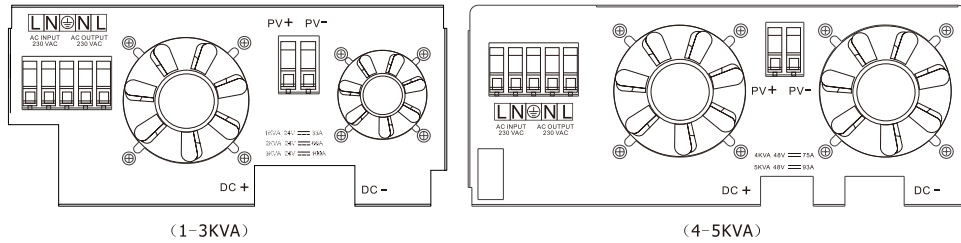
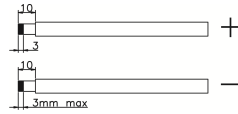

3. Make sure the wires are securely connected.

Final Assembly

After connecting all wirings, please put bottom cover back by screwing two screws as shown below.

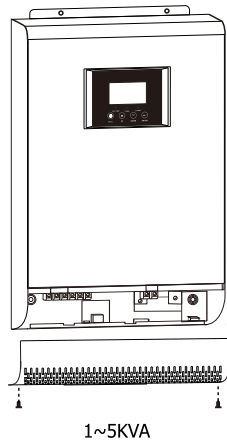

Communication Connection

Please use supplied communication cable to connect to inverter and PC. Insert bundled CD into a computer and follow on-screen instruction to install the monitoring software. For the detailed software operation, please check user manual of software inside of CD.

Dry Contact Signal

There is one dry contact (3A/250VAC) available on the rear panel. It could be used to deliver signal to external device when battery voltage reaches warning level.

Unit Status	Condition		Dry contact port		
			NC & C	NO & C	
Power Off	Unit is off and no output is powered.		Close	Open	
Power On	Output is powered from Utility		Close	Open	
	Output is powered From Battery or Solar.	Program 01 set as Utility	Battery voltage < Low DC warning voltage	Open	Close
			Battery voltage > Setting value in Program 09 or battery charging reaches floating stage	Close	Open
	Program 01 is set as SBU, SOL		Battery voltage < Setting value in Program 08	Open	Close
		Battery voltage > Setting value in Program 09 or battery charging reaches floating stage	Close	Open	

OPERATION

Power ON/OFF

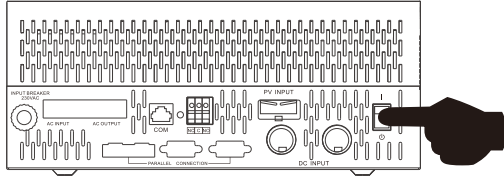

Once the unit has been properly installed and the batteries are connected well, simply press On/Off switch (located on the button of the case) to turn on the unit.

Operation and Display Panel

The operation and display panel, shown in below chart, is on the front panel of the inverter. It includes three indicators, four function keys and a LCD display, indicating the operating status and input/output power information.

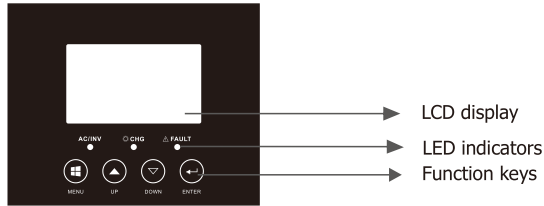

LED Indicator

LED Indicator		Messages	
AC/ INV	Green	Solid On	Output is powered by grid in Line mode.
		Flashing	Output is powered by battery or PV in battery mode.
CHG	Yellow	Flashing	Battery is charging or discharging.
FAULT	Red	Solid On	Fault occurs in the inverter.
		Flashing	Warning condition occurs in the inverter.

Function Keys

Function Keys	Description
MENU	Enter or exit setting mode or go to previous selection.
UP	Increase the setting data.
DOWN	Decrease the setting data.
ENTER	Confirm the selection in setting mode or go to next selection.

LCD Display Icons

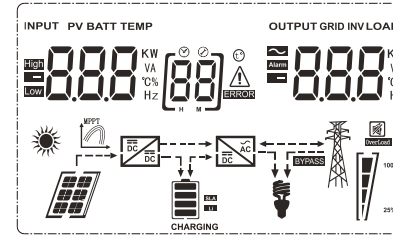

Icon	Function description	
Input Source Information and Output Information		
	Indicates the AC information.	
	Indicates the DC information.	
	Indicate input voltage, input frequency, PV voltage, battery voltage and charger current. Indicate output voltage, output frequency, load in VA, load in Watt and discharging current.	
Configuration Program and Fault Information		
	Indicates the setting programs.	
	Indicates the warning and fault codes. Warning: flashing with warning code. Fault: lighting with fault code.	
Battery Information		
	Indicates battery level by 0-24%, 25-49%, 50-74% and 75-100% in battery mode and charging status in line mode.	
In AC mode, it will present battery charging status.		
Status	Battery voltage	LCD Display
Constant Current mode / Constant Voltage mode	<2V/cell	4 bars will flash in turns.
	2 ~ 2.083V/cell	Bottom bar will be on and the other three bars will flash in turns.
	2.083 ~ 2.167V/cell	Bottom two bars will be on and the other two bars will flash in turns.
	> 2.167 V/cell	Bottom three bars will be on and the top bar will flash.
Batteries are fully charged.		4 bars will be on.

In battery mode, it will present battery capacity.				
Load Percentage	Battery Voltage		LCD Display	
Load >50%	< 1.717V/cell			
	1.717V/cell ~ 1.8V/cell			
	1.8 ~ 1.883V/cell			
	> 1.883 V/cell			
50%> Load > 20%	< 1.817V/cell			
	1.817V/cell ~ 1.9V/cell			
	1.9 ~ 1.983V/cell			
	> 1.983			
Load < 20%	< 1.867V/cell			
	1.867V/cell ~ 1.95V/cell			
	1.95 ~ 2.033V/cell			
	> 2.033			
Load Information				
	Indicates overload.			
	Indicates the load level by 0-24%, 25-50%, 50-74% and 75-100%.			
	0%~25%	25%~50%	50%~75%	75%~100%
Mode Operation Information				
	Indicates unit connects to the mains.			
	Indicates unit connects to the PV panel.			
	Indicates load is supplied by utility power.			
	Indicates the solar charger is working.			
	Indicates the DC/AC inverter circuit is working.			
Mute Operation				
	Indicates unit alarm is disabled.			

LCD Setting

After pressing and holding MENU button for 2 seconds, the unit will enter setting mode. Press "UP" or "DOWN" button to select setting programs. And then, press "ENTER" or "MENU" button to confirm the selection and exit.

Setting Programs:

Program	Selectable option	Description
		Select the setting of inverter.
		Select the setting of solar charger.
		Select the setting of the system.
INVERTER		
Power use mode	Utility first (default) 	UTI: Utility will provide power to the loads as first priority. Solar and battery energy will provide power to the loads only when utility power is not available. SOL: The inverter will turn to off grid state when the solar energy is enough. SBU: Solar energy provides power to the loads as first priority. If solar energy is not sufficient to power all connected loads, battery energy will supply power to the loads at the same time.
	Solar first 	
	SBU priority 	
Maximum charging current(DC)	4/5KVA models: 	To configure total charging current for solar and utility chargers. (Max. charging current=utility charging current+solar charging current)
	60A(default) 110A(max) 	
	2/3KVA models: 	
	60A(default) 80A(max) 	
Maximum Grid charging current(DC)	4/5KVA models: 	
	30A(default) 60A(max) 	

	2/3KVA models: 20A(default) 200 A 30A(max) 300 A	
AC input voltage range	Narrow (default) 05 F5t	If selected, acceptable AC input voltage range will be within 170-280VAC.
	Wide 05 5Lo	If selected, acceptable AC input voltage range will be within 90-280VAC.
	APP-VDE4105 05 APPL	If selected, acceptable AC input voltage range will conform to VDE4105(184-253VAC).
Power saving (Search mode enable/disable)	Saving mode disable(default) 06 5d5	If disabled, no matter connected load is low or high,the on/off status of inverter output will not be effected.
	Saving mode enable 06 5eN	If enable, the inverter begins search mode if the AC load connected is pretty low or not detected, The inverter's "search" mode reduces stand-by energy consumption during no-load conditions.
Setting the min voltage point	4/5KVA models: 45.0V-54.0V(default) 07 480 v	SBU: When the battery voltage is lower than the setting point, the inverter will start recharging to the battery.(4KVA/5KVA model)
	2/3KVA models: 22.5V-27.0V(default) 07 250 v	SBU: Utility provides power to the loads only when battery voltage drops to the setting point.(2KVA/3KVA model) UTI: no use. SOL: When the battery voltage is lower than the setting point, the inverter will start recharging to the battery.
	4/5KVA models: 48.0V-55.0V(default) 08 530 v	SBU: When the battery voltage is higher than the setting point, the inverter will supply the power match the load.When the battery voltage is lower than the setting point, the inverter will stop discharging from battery.(4KVA/5KVA model)
Setting the balance voltage point	2/3KVA models: 24.0V-27.5V(default) 08 270 v	SBU: no use.(2KVA/3KVA model) UTI: When the battery voltage is lower than the setting point, the inverter will start recharging the battery. SOL: When the battery voltage is lower than the setting point, the inverter will back to the utility source.





















Setting the max voltage point	4/5KVA models: 50.0V-58.0V default 09 540 v	SBU: In this mode when the battery voltage is higher than the setting point, the inverter will discharge match the load.(4KVA/5KVA model) SBU: When the battery voltage is higher than the setting point, the inverter will back to the off grid. (2KVA/3KVA model)
	2/3KVA models: 25.0V-29.0V(default) 09 282 v	UTI: In this mode when the battery voltage is higher than the setting point, the inverter will stop charging to battery. SOL: When the battery voltage is higher than the setting point, the inverter will back to the off grid state.
Low DC cut-off voltage	4/5KVA models: 40.0V-48.0V(default) 10 420 v	48V model default setting: 42.0V Setting range is from 40.0V to 48.0V, Increment of each click is 0.1V. 24V model default setting: 21.0V Setting range is from 20.0V to 24.0V, Increment of each click is 0.1V.
	2/3KVA models: 20.0V-24.0V(default) 10 210 v	Low DC cut-off voltage will be fixed to setting value no matter what percentage of load is connected.
Low DC recovery voltage	4/5KVA models: 40.0V-50.0V(default) 11 440 v	If the inverter is in the low voltage fault state of the battery, the battery voltage higher than the voltage, inverter will remove the battery low voltage fault.
	2/3KVA models: 20.0V-25.0V(default) 11 220 v	
High DC cut-off voltage	4/5KVA models: 58.0V-60.0V(default) 12 600 v	48V model default setting: 60.0V Setting range is from,58.0V to 60.0V. Increment of each click is 0.1V High DC cut-off voltage will be fixed to setting value no matter what percentage of load is connected.
	2/3KVA models: 29.0V-30.0V(default) 12 300 v	24V model default setting: 30.0V Setting range is from,29.0V to 30.0V. Increment of each click is 0.1V High DC cut-off voltage will be fixed to setting value no matter what percentage of load is connected.
	on (default) 13 0N	Turn on the inverter output when the grid is off.
Off-Grid enable	off 13 OFF	Shut down the inverter output when the grid is off.
	Grid-use enable (default) 14 UEN	Enable the inverter to connect to an AC input source.











	Grid-use disable [14] UDS	Disable the inverter to connect to an AC input source.
Low battery voltage Protection mode	(default) [15] UAL	If "Usually -Defined" is selected, low DC cut-off voltage and low DC Warning Return Voltage will follow the table 2.
	User-Defined [15] USE	If "User-Defined" is selected, low DC cut-off voltage and low DC Warning Return Voltage can be set up in program 10 and 11.
Output voltage	(default) [16] 230 ^v	Set the output voltage amplitude (220VAC-240VAC)
Output frequency	(default) [17] 500 ^{Hz}	50Hz.
	[17] 600 ^{Hz}	60Hz.
Grid charge enable	(default) [18] UCE	Enable grid charge.
	[18] UCd	Disable grid charge
CHARGER		
Solar Charger working switch	(default) [41] ON	Open or close the Solar Charger Controller output.
	[41] OFF	
Battery type	(default) [42] Pb	Select the battery type.(Lead acid or Lithium)
	[42] L	
Battery AH	100AH-900AH (default) [43] 200	Set the AH of the battery
Solar Charger absorb voltage	48V models: 50.0V-54.0V(default)	Set the Absorb voltage,(Refer to the Charging Curve)
	[44] 500 ^v	

	24V models: 25.0V-27.0V(default) [44] 250 ^v	
Solar Charger refloat voltage	48V models: 51.0V-55.0V(default) [45] 548 ^v	Set the Refloat voltage.(Refer to the Charging Curve)
	24V models: 25.5V-27.5V(default) [45] 274 ^v	
	48V models: 53.0V-58.0V(default) [46] 572 ^v	
Solar Charger float voltage	24V models: 26.5V-29.0V(default) [46] 286 ^v	Set the float voltage.(Refer to the Charging Curve)
	Solar Charger max current [47] 500 ^A	
Solar Charger absorb current [48] 100 ^A	1.0A-50.0A(default) [47] 500 ^A	Set the max output current of the Solar Charge Controller.(Refer to the Charging Curve)
Solar Charger low DC cut-off voltage	5.0A-30.0A(default) [48] 100 ^A	Set the absorb current of the Solar Charge Controller.(Refer to the Charging Curve)
	48V models: 34.0V-44.0V(default) [49] 340 ^v	
Solar Charger high DC cut-off voltage	24V models: 17.0V-22.0V(default) [49] 170 ^v	If the battery voltage is lower than the set point, the Solar Charge Controller will close the output.
	48V models: 58.0V-60.0V(default) [50] 600 ^v	
Solar Charger absorb voltage	24V models: 29.0V-30.0V(default) [50] 300 ^v	If the battery voltage is higher than the set point, the Solar Charge Controller will close the output.















SYSTEM		
Auto restart when overload occurs	[61] L [Ⓢ] E	Restart enable.
	(default) [61] L [Ⓢ] d	Restart disable.
Auto restart when over temperature occurs	(default) [62] t [Ⓢ] E	Restart enable.
	[62] t [Ⓢ] d	Restart disable.
Overload bypass; When enabled, the unit will transfer to line mode if overload occurs in battery mode	(default) [63] b [Ⓢ] E	Bypass enable.
	[63] b [Ⓢ] d	Bypass disable.
Auto turn page	(default) [64] P [Ⓢ] E	If selected, the display screen will stay at latest screen user finally switches.
	[64] P [Ⓢ] d	If selected, the display screen will auto turn the display page.
Beeps while Utility source is interrupted	(default) [65] R [Ⓢ] O F	Beeps off.
	[65] R [Ⓢ] O N	Beeps on.
Alarm control	(default) [66] b [Ⓢ] O N	Alarm on.
	[66] b [Ⓢ] O F	Alarm off.
Backlight control	(default) [67] L [Ⓢ] O F	Backlight off.
	[67] L [Ⓢ] O N	Backlight on.
Record Fault code	(default) [68] F [Ⓢ] O N	Record enable.
	[68] F [Ⓢ] O F	Record disable.

Fault Reference Code







Fault Code	Fault Event	Icon on
01	Fan is locked when inverter is off	[01] 
02	Inverter transformer over temperature	[02] 
03	battery voltage is too high	[03] 
04	battery voltage is too low	[04] 
05	Output short circuited	[05] 
06	Inverter output voltage is high	[06] 
07	Overload time out	[07] 
08	Inverter bus voltage is too high	[08] 
09	Bus soft start failed	[09] 
11	Main relay failed	[11] 
21	Inverter output voltage sensor error	[21] 
22	Inverter grid voltage sensor error	[22] 
23	Inverter output current sensor error	[23] 
24	Inverter grid current sensor error	[24] 
25	Inverter load current sensor error	[25] 
26	Inverter grid over current error	[26] 
27	Inverter radiator over temperature	[27] 
31	Solar charger battery voltage class error	[31] 
32	Solar charger current sensor error	[32] 
33	Solar charger current is uncontrollable	[33] 

41	Inverter grid voltage is low	[41] 
42	Inverter grid voltage is high	[42] 
43	Inverter grid under frequency	[43] 
44	Inverter grid over frequency	[44] 
51	Inverter over current protection error	[51] 
52	Inverter bus voltage is too low	[52] 
53	Inverter soft start failed	[53] 
55	Over DC voltage in AC output	[55] 
56	Battery connection is open	[56] 
57	Inverter control current sensor error	[57] 
58	Inverter output voltage is too low	[58] 

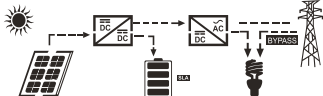
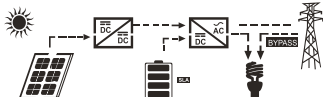
Warning Indicator

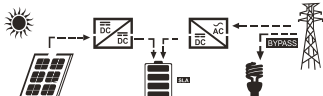
Fault Code	Fault Event	Icon on
61	Fan is locked when inverter is on.	[61] 
62	Fan 2 is locked when inverter is on.	[62] 
63	Battery is over-charged.	[63] 
64	Low battery.	[64] 
67	Overload.	[67]   
70	Output power derating.	[70] 
72	Solar charger stops due to low battery.	[72] 
73	Solar charger stops due to high PV voltage.	[73] 
74	Solar charger stops due to over load.	[74] 
75	Solar charger over temperature.	[75] 
76	PV charger communication error.	[76] 
77	Parameter error.	[77] 

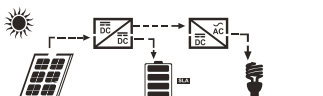
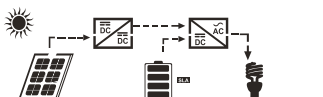
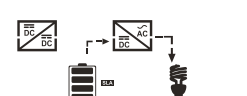
Operating State Description

Operation state	Description	LCD display
Match load state Note: DC power produced from your solar array is converted by the inverter into AC power, which is then sent to your main electrical panel to be used by your household appliances. Any excess power generated is not sold back to the grid, but stored in battery.	PV energy is charger into the battery or converted by the inverter to the AC load.	PV energy power is larger than inverter power 
		PV energy power is smaller than inverter power 
		PV is off 
Charge state	PV energy and grid cancharge batteries.	
Bypass state	Error are caused by inside circuit error or external reasons such as over temperature, output short circuited and so on.	
Off-Grid state	The inverter will provide output power from battery and PV power.	Inverter power loads from PV energy 
		Inverter power loads from battery and PV energy 
		Inverter power loads from battery only 
Stop mode	The inverter stop working if you turn off the inverter by the soft key or error has occurred in the condition of no grid.	

Display Setting

The LCD display information will be switched in turns by pressing "UP" or "DOWN" key. The selectable information is switched as below order: battery voltage, battery current, inverter voltage, inverter current, grid voltage, grid current, load in Watt, load in VA, grid frequency, inverter frequency, PV voltage, PV charging power, PV charging output voltage, PV charging current.

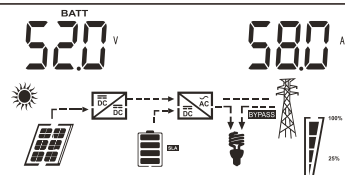
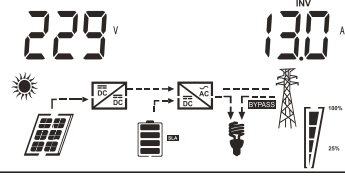
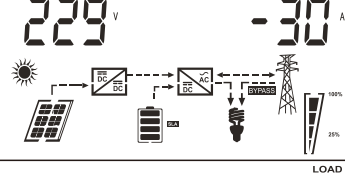
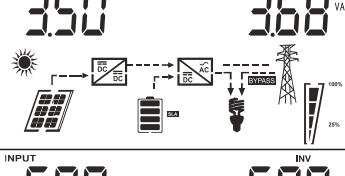
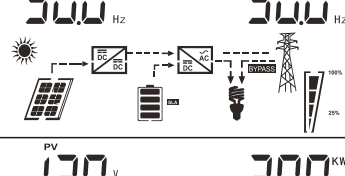
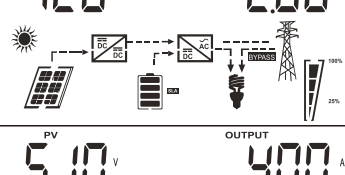
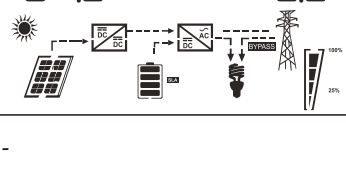
Selectable information	LCD display
Battery voltage/DC discharging current	
Inverter output voltage/Inverter output current	
Grid voltage/Grid current	
Load in Watt/VA	
Grid frequency/Inverter frequency	
PV voltage and power	
PV charger output voltage and MPPT charging current	

SPECIFICATIONS

Table 1 Line Mode Specifications

INVERTER MODEL	1KVA	2KVA	3KVA	4KVA	5KVA
Input Voltage Waveform	Sinusoidal (utility or generator)				
Nominal Input Voltage	230Vac				
Low Loss Voltage	90Vac±7V(SLO); 170Vac±7V(FST) 186Vac±7V(APL)				
Low Loss Return Voltage	100Vac±7V(SLO); 180Vac±7V(FST) 196Vac±7V(APL)				
High Loss Voltage	280Vac±7V(FST, SLO) 253Vac±7V(APL)				
High Loss Return Voltage	270Vac±7V(FST, SLO) 250Vac±7V(APL)				
Max AC Input Voltage	300Vac				
Nominal Input Frequency	50Hz / 60Hz (Auto detection)				
Low Loss Frequency	40HZ±1HZ(FST, SLO) 47.5HZ±0.05HZ(APL)				
Low Loss Return Frequency	42HZ±1HZ(FST, SLO) 47.5HZ±0.05HZ(APL)				
High Loss Frequency	65HZ±1HZ(FST, SLO) 51.5HZ±0.05HZ(APL)				
High Loss Return Frequency	63HZ±1HZ(FST, SLO) 50.05HZ±0.05HZ(APL)				
Output Short Circuit Protection	Line mode: Circuit Breaker Battery mode: Electronic Circuits				
Efficiency (Line Mode)	>95% (Rated R load, battery full charged)				
Transfer Time	10ms typical (FST,APL) 20ms typical (SLO)				
Output power derating: When AC input voltage drops to 170V depending on models, the output power will be derated	<p>230Vac model:</p> <p>Output Power</p> <p>Rated Power</p> <p>50% Power</p> <p>90V 170V 280V</p>				

Table 2 Invert Mode Specifications

INVERTER MODEL	1KVA	2KVA	3KVA	4KVA	5KVA
Rated Output Power	1KVA/0.8KW	2KVA/1.6KW	3KVA/2.4KW	4KVA/3.2KW	5KVA/4KW
Output Voltage Waveform	Pure Sine Wave				
Output Voltage Regulation	230Vac±5%				
Output Frequency	60Hz or 50Hz				
Peak Efficiency	90%				
Overload Protection	5s@≥150% load; 10s@110%~150% load				
Surge Capacity	2* rated power for 5 seconds				
Nominal DC Input Voltage	12Vdc	24Vdc	48Vdc		
Cold Start Voltage	11.5Vdc	23.0Vdc	46.0Vdc		
Low DC Warning Voltage					
@ load < 20%	11.0Vdc	22.0Vdc	44.0Vdc		
@ 20% ≤ load < 50%	10.7Vdc	21.4Vdc	42.8Vdc		
@ load ≥ 50%	10.1Vdc	20.2Vdc	40.4Vdc		
Low DC Warning Return Voltage					
@ load < 20%	11.5Vdc	23.0Vdc	46.0Vdc		
@ 20% ≤ load < 50%	11.2Vdc	22.4Vdc	44.8Vdc		
@ load ≥ 50%	10.6Vdc	21.2Vdc	42.4Vdc		
Low DC Cut-off Voltage					
@ load < 20%	10.5Vdc	21.0Vdc	42.0Vdc		
@ 20% ≤ load < 50%	10.2Vdc	20.4Vdc	40.8Vdc		
@ load ≥ 50%	9.6Vdc	19.2Vdc	38.4Vdc		
High DC Recovery Voltage	14.5Vdc	29Vdc	58Vdc		
High DC Cut-off Voltage	15.5Vdc	31Vdc	60Vdc		
No Load Power Consumption	<15W	<20W	<50W		
Saving Mode Power Consumption	<5W	<10W	<15W		

*4KVA/5KVA only supports 230VAC system.

Table 3 Charge Mode Specifications

Utility Charging Mode						
INVERTER MODEL		1KVA	2KVA	3KVA	4KVA	5KVA
Charging Current(FST) @Nominal Input Voltage		10/20A	20/30A		1-60A	
Absorption Voltage	Flooded Battery, AGM / Gel Battery	12.5	25		50	
	LI	13.2	26.4		52.8	
Refloat Voltage	Flooded Battery, AGM / Gel Battery	13.7	27.4		54.8	
	LI	13.4	26.8		53.6	
Float Voltage	Flooded Battery, AGM / Gel Battery	14.3	28.6		57.2	
	LI	13.5	27		54	
Charing Algorithm		3-Step(Flooded Battery, AGM/Gel Battery), 4-Step(LI)				
Solar Charging Mode						
INVERTER MODEL		1KVA	2KVA	3KVA	4KVA	5KVA
Charging Current (PWM)		50Amp				
System DC Voltage		12Vdc	24Vdc	48Vdc		
Operating Voltage Range		15-18Vdc	30-32Vdc	60-72Vdc		
Max.PV Array Open Circuit Voltage		30Vdc	75Vdc	105Vdc		
Standby Power Consumption		1W	2W			
Battery Voltage Accuracy		+/-0.3%				
PV Voltage Accuracy		+/-2V				
Charging Algorithm		3-Step(Flooded Battery, AG M/Gel Battery),4-Step(LI)				
Charging algorithm for lead acid battery						

Charging algorithm for Lithium battery						
INVERTER MODEL		1KVA	2KVA	3KVA	4KVA	5KVA
Max Charging Current		70Amp	80Amp		110Amp	
Default Charging Current		50Amp				
Joint Utility and Solar Charging						
INVERTER MODEL		1KVA	2KVA	3KVA	4KVA	5KVA
Max Charging Current		70Amp	80Amp		110Amp	
Default Charging Current		50Amp				

Table 4 General Specifications

INVERTER MODEL	1KVA	2KVA	3KVA	4KVA	5KVA
Safety Certification	CE				
Operating Temperature Range	-0°C to 55°C				
Storage temperature	-15°C~ 60°C				
Dimension (D*W*H), mm	240 x 316 x 95	277x 355 x 100		297.5 x 468 x 125	
Net Weight, kg	5.0	6.4	6.9	10.2	

TROUBLE SHOOTING

Problem	LCD/LED/Buzzer	Explanation/Possible cause	What to do
Unit shuts down automatically during startup process.	LCD/LEDs and buzzer will be active for 3 seconds and then complete off.	The battery voltage is too low. (<1.91V/Cell)	1. Re-charge battery. 2. Replace battery.
No response after power on.	No indication.	1. The battery voltage is far too low. (<1.4V/Cell) 2. Battery polarity is connected reversed.	1. Check if batteries and the wiring are connected well. 2. Re-charge battery. 3. Replace battery.
Mains exist but the unit works in battery mode.	Input voltage is displayed as 0 on the LCD and green LED is flashing.	Input protector is tripped.	Check if AC breaker is tripped and AC wiring is connected well.
	Green LED is flashing.	Insufficient quality of AC power. (Shore or Generator)	1. Check if AC wires are too thin and/or too long. 2. Check if generator (if applied) is working well or check if input voltage range setting is correct. (Appliance–Wide)
When the unit is turned on, internal relay is switched on and off repeatedly.	LCD display and LED are flashing.	Battery is disconnected.	Check if battery wires are connected well.
Buzzer beeps continuously and red LED is on.	Fault code 07	Overload error. The inverter is overload 110%and time is up.	Reduce the connected load by switching off some equipment.
	Fault code 05	Output short circuited.	Check if wiring is connected well and remove abnormal load.
	Fault code 02	Internal temperature of inverter component is over 90°C.	Check whether the air flow of the unit is blocked or whether the ambient temperature is too high.
	Fault code 03	Battery is over charged.	Return to repair center.
		The battery voltage is too high.	Check if spec and quantity of batteries are meet requirements.
	Fault code 01	Fan fault.	Replace the fan.
	Fault code 06/58	Output abnormal .(Inverter voltage below than 202Vac or is higher than 253Vac)	1. Reduce the connected load. 2. Return to repair center
	Fault code 08/09/53/57	Internal components failed.	Return to repair center
	Fault code 51	Over current or surge.	Restart the unit, if the error happens again, please return to repair center.
	Fault code 52	Bus voltage is too low.	
Fault code 55	Output voltage is unbalanced.		
Fault code 56	Battery is not connected well or fuse is burnt.	If the battery is connected well, please return to repair center.	

Appendix: Approximate Back-up Time Table

Model	Load (VA)	Backup Time @ 12Vdc 100Ah (min)	Backup Time @ 12Vdc 200Ah (min)
1KVA	100	766	1610
	200	335	766
	300	198	503
	400	139	339
	500	112	269
	600	95	227
	700	81	176
	800	62	140
	900	55	125
1000	50	112	

Model	Load (VA)	Backup Time @ 24Vdc 100Ah (min)	Backup Time @ 24Vdc 200Ah (min)
2KVA	200	766	1610
	400	335	766
	600	198	503
	800	139	339
	1000	112	269
	1200	95	227
	1400	81	176
	1600	62	140
	1800	55	125
	2000	50	112
3KVA	300	449	1100
	600	222	525
	900	124	303
	1200	95	227
	1500	68	164
	1800	56	126
	2100	48	108
	2400	35	94
2700	31	74	
3000	28	67	

Model	Load (VA)	Backup Time @ 48Vdc 100Ah (min)	Backup Time @ 48Vdc 200Ah (min)
4KVA	400	766	1610
	800	335	766
	1200	198	503
	1600	139	339
	2000	112	269
	2400	95	227
	2800	81	176
	3200	62	140
	3600	55	125
	4000	50	112

5KVA	500	613	1288
	1000	268	613
	1500	158	402
	2000	111	271
	2500	90	215
	3000	76	182
	3500	65	141
	4000	50	112
	4500	44	100
	5000	40	90

Note: Backup time depends on the quality of the battery, age of battery and type of battery. Specifications of batteries may vary depending on different manufacturers.