

USER MANUAL
HYBRID SOLAR INVERTER

USER MANUAL
HYBRID SOLAR INVERTER
MPPT 1KVA-5KVA

Appliances



PC



TV



Air-conditioning



Fridge



Washing machine

Table Of Contents

ABOUT THIS MANUAL	1
Purpose	1
Scope	1
SAFETY INSTRUCTIONS	1
INTRODUCTION	2
Features	2
Basic System Architecture	2
Product Overview	3
INSTALLATION	4
Unpacking and Inspection	4
Preparation	4
Mounting the Unit	4
Battery Connection	5
AC Input/Output Connection	7
PV Connection	8
Final Assembly	9
Communication Connection	10
Dry Contact Signal	10
OPERATION	11
Power ON/OFF	11
Operation and Display Panel	11
LCD Display Icons	12
LCD Setting	14
Fault Reference Code	21
Warning Indicator	23
Operating Mode Description	23
Display Setting	25
SPECIFICATIONS	27
Table 1 Line Mode Specifications	27
Table 2 Inverter Mode Specifications	28
Table 3 Charge Mode Specifications	29
Table 4 General Specifications	30
TROUBLE SHOOTING	31
Appendix: Approximate Back-up Time Table	32

Model	Load (VA)	Backup Time @ 48Vdc 100Ah (min)	Backup Time @ 48Vdc 200Ah (min)
4KVA	400	766	1610
	800	335	766
	1200	198	503
	1600	139	339
	2000	112	269
	2400	95	227
	2800	81	176
	3200	62	140
	3600	55	125
	4000	50	112
5KVA	500	613	1288
	1000	268	613
	1500	158	402
	2000	111	271
	2500	90	215
	3000	76	182
	3500	65	141
	4000	50	112
	4500	44	100
	5000	40	90

Note: Backup time depends on the quality of the battery, age of battery and type of battery. Specifications of batteries may vary depending on different manufacturers.

Appendix: Approximate Back-up Time Table

Model	Load (VA)	Backup Time @12Vdc 100Ah (min)	Backup Time @12Vdc 200Ah (min)
1KVA	200	335	766
	400	139	339
	600	95	227
	800	62	140
	1000	50	112

Model	Load (VA)	Backup Time @24Vdc 100Ah (min)	Backup Time @24Vdc 200Ah (min)
2KVA	200	766	1610
	400	335	766
	600	198	503
	800	139	339
	1000	112	269
	1200	95	227
	1400	81	176
	1600	62	140
	1800	55	125
	2000	50	112
3KVA	300	449	1100
	600	222	525
	900	124	303
	1200	95	227
	1500	68	164
	1800	56	126
	2100	48	108
	2400	35	94
	2700	31	74
	3000	28	67

ABOUT THIS MANUAL

Purpose

This manual describes the assembly, installation, operation and troubleshooting of this unit. Please read this manual carefully before installations and operations. Keep this manual for future reference.

Scope

This manual provides safety and installation guidelines as well as information on tools and wiring.

SAFETY INSTRUCTIONS



WARNING: This chapter contains important safety and operating instructions. Read and keep this manual for future reference.

- Before using the unit, read all instructions and cautionary markings on the unit the batteries and all appropriate sections of this manual.
- CAUTION** --To reduce risk of injury, charge only deep-cycle lead acid type rechargeable batteries. Other types of batteries may burst, causing personal injury and damage.
- Do not disassemble the unit. Take it to a qualified service center when service or repair is required. Incorrect re-assembly may result in a risk of electric shock or fire.
- To reduce risk of electric shock, disconnect all wirings before attempting any maintenance or cleaning. Turning off the unit will not reduce this risk.
- CAUTION** --Only qualified personnel can install this device with battery.
- NEVER** charge a frozen battery.
- For optimum operation of this inverter/charger, please follow required spec to select appropriate cable size. It' s very important to correctly operate this inverter/charger.
- Be very cautious when working with metal tools on or around batteries. A potential risk exists to drop a tool to spark or short circuit batteries or other electrical parts and could cause an explosion.
- Please strictly follow installation procedure when you want to disconnect AC or DC terminals. Please refer to INSTALLATION section of this manual for the details.
- Fuses (3 pieces of 40A, 32VDC for 1KVA, 4 pieces of 40A, 32VDC for 2KVA and 6 pieces for 3KVA, 1 piece of 200A, 58VDC for 4KVA and 5KVA) are provided as over-current protection for the battery supply.
- GROUNDING INSTRUCTIONS** -This inverter/charger should be connected to a permanent grounded wiring system. Be sure to comply with local requirements and regulation to install this inverter.
- NEVER** cause AC output and DC input short circuited. Do NOT connect to the mains when DC input short circuits.
- Warning!!** Only qualified service persons are able to service this device. If errors still persist after following troubleshooting table, please send this inverter/charger back to local dealer or service center for maintenance.

INTRODUCTION

This is a multi-function inverter/charger, combining functions of inverter, MPPT solar charger and battery charger to offer uninterruptible power support with portable size. Its comprehensive LCD display offers user-configurable and easy-accessible button operation such as battery charging current, AC/solar charger priority, and acceptable input voltage based on different applications.

Features

- Pure sine wave inverter
- Built-in MPPT solar charge controller
- Configurable input voltage range for home appliances and personal computers via LCD setting
- Configurable battery charging current based on applications via LCD setting
- Configurable AC/Solar Charger priority via LCD setting
- Compatible to mains voltage or generator power
- Auto restart while AC is recovering
- Overload/ Over temperature/ short circuit protection
- Smart battery charger design for optimized battery performance
- Cold start function

Basic System Architecture

The following illustration shows basic application for this inverter/charger. It also includes following devices to have a complete running system:

- Generator or Utility.
- PV modules (option)

Consult with your system integrator for other possible system architectures depending on your requirements.

This inverter can power all kinds of appliances in home or office environment, including motor-type appliances such as tube light, fan, refrigerator and air conditioner.

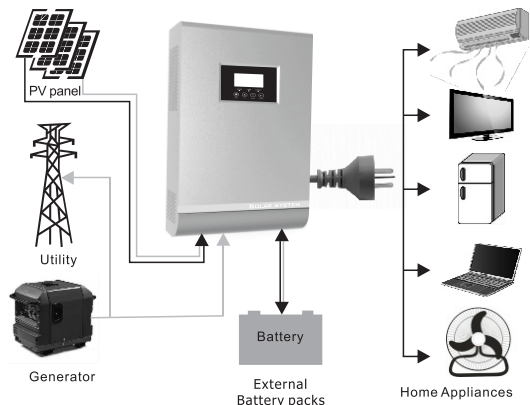
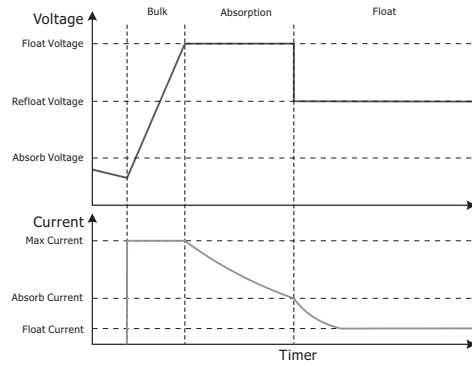

Figure 1 Hybrid Power System

TROUBLE SHOOTING

Problem	LCD/LED/Buzzer	Explanation / Possible cause	What to do
Unit shuts down automatically during startup process.	LCD/LEDs and buzzer will be active for 3 seconds and then complete off.	The battery voltage is too low (<1.91V/Cell)	1. Re-charge battery. 2. Replace battery.
No response after power on.	No indication.	1. The battery voltage is far too low. (<1.4V/Cell) 2. Battery polarity is connected reversed.	1. Check if batteries and the wiring are connected well. 2. Re-charge battery. 3. Replace battery.
Mains exist but the unit works in battery mode.	Input voltage is displayed as 0 on the LCD and green LED is flashing.	Input protector is tripped	Check if AC breaker is tripped and AC wiring is connected well.
	Green LED is flashing.	Insufficient quality of AC power. (Shore or Generator)	1. Check if AC wires are too thin and/or too long. 2. Check if generator (if applied) is working well or if input voltage range setting is correct. (Appliance⇒wide)
When the unit is turned on, internal relay is switched on and off repeatedly.	LCD display and LEDs are flashing	Battery is disconnected.	Check if battery wires are connected well.
Buzzer beeps continuously and red LED is on.	Fault code 07	Overload error. The inverter is overload 110% and time is up.	Reduce the connected load by switching off some equipment.
	Fault code 05	Output short circuited.	Check if wiring is connected well and remove abnormal load.
		Internal temperature of inverter component is over 90°C.	Check whether the air flow of the unit is blocked or whether the ambient temperature is too high.
	Fault code 02		
	Fault code 03	Battery is over-charged.	Return to repair center.
		The battery voltage is too high.	Check if spec and quantity of batteries are meet requirements.
	Fault code 01	Fan fault	Replace the fan.
	Fault code 06/58	Output abnormal (Inverter voltage below than 202Vac or is higher than 253Vac)	1. Reduce the connected load. 2. Return to repair center
	Fault code 08/09/53/57	Internal components failed.	Return to repair center.
	Fault code 51	Over current or surge.	Restart the unit, if the error happens again, please return to repair center.
	Fault code 52	Bus voltage is too low.	
	Fault code 55	Output voltage is unbalanced.	If the battery is connected well, please return to repair center.
Fault code 56	Battery is not connected well or fuse is burnt.		

Charging algorithm for lead acid battery



Charging algorithm for Lithium battery

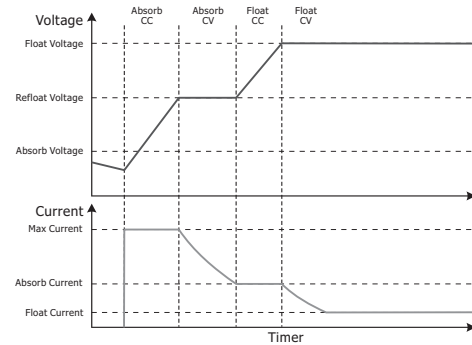

Joint Utility and Solar Charging

INVERTER MODEL	1012/50A	2024/60A 3024/60A	4048/60A 5048/60A	4048/80A 5048/80A
Max Charging Current	70A	80A	120A	140A
Default Charging Current	50A	60A	60A	80A

Table 4 General Specifications

INVERTER MODEL	1012/50A	2024/60A 3024/60A	4048/60A 5048/60A	4048/80A 5048/80A
Safety Certification	CE			
Operating Temperature Range	-0°C to 55°C			
Storage temperature	-15°C to 60°C			
Dimension (D*W*H), mm	354 x 272 x 128		528 x295 x141	
Net Weight, kg	7.4	11.5	12.5	13.5

Product Overview

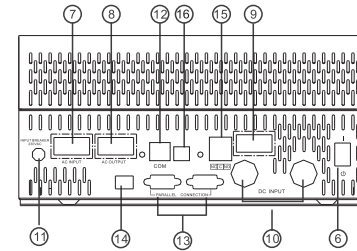
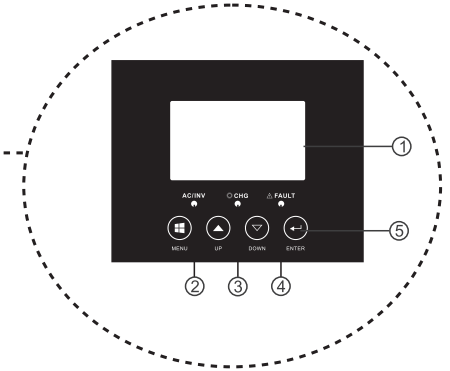
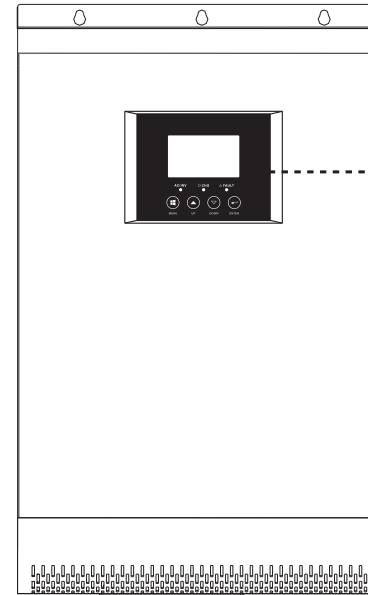

4KVA- 5KVA parallel model

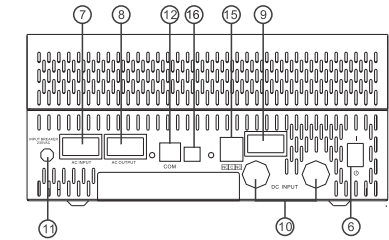

4KVA- 5KVA single model

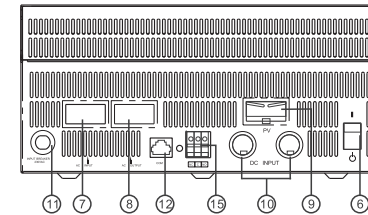

1KVA- 3KVA single model

1. LCD display
2. Status indicator
3. Charging indicator
4. Fault indicator
5. Function buttons
6. Power on/off switch
7. AC input
8. AC output
9. PV input
10. Battery input
11. Circuit breaker
12. RS485 communication port
13. Parallel communication port (only for parallel model)
14. Parallel switch
15. Dry contact
16. USB

NOTE: For parallel model installation and operation, please check separate parallel installation guide for the details.

INSTALLATION

Unpacking and Inspection

Before installation, please inspect the unit. Be sure that nothing inside the package is damaged. You should have received the following items inside of package:

- The unit x 1
- User manual x 1
- Communication cable x 1
- Software CD x 1

Preparation

Before connecting all wirings, please take off bottom cover by removing two screws as shown below.

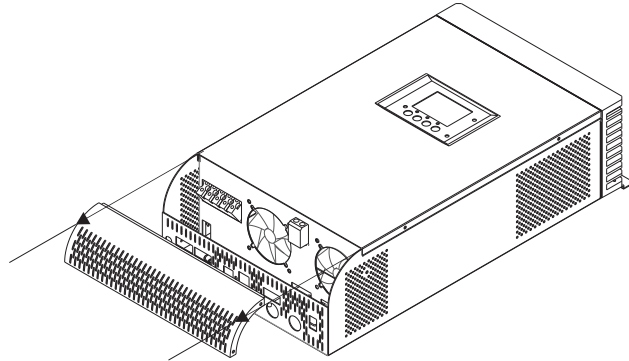

Mounting the Unit

Consider the following points before selecting where to install:

- Do not mount the inverter on flammable construction materials.
- Mount on a solid surface
- Install this inverter at eye level in order to allow the LCD display to be read at all times.
- For proper air circulation to dissipate heat, allow a clearance of approx. 20 cm to the side and approx. 30 cm above and below the unit.
- The ambient temperature should be between 0°C and 55°C to ensure optimal operation.
- The recommended installation position is to be adhered to the wall vertically.
- Be sure to keep other objects and surfaces as shown in the diagram to guarantee sufficient heat dissipation and to have enough space for removing wires.

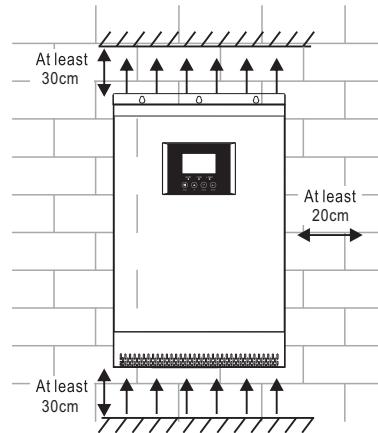

⚠️ SUITABLE FOR MOUNTING ON CONCRETE OR OTHER NON-COMBUSTIBLE SURFACE ONLY.

Table 3 Charge Mode Specifications

Utility Charging Mode				
INVERTER MODEL	1012/50A	2024/60A 3024/60A	4048/60A 4048/80A 5048/60A 5048/80A	
Charging Current(FST) @ Nominal Input Voltage	10/20A	20/30A	1~60A	
Absorption Voltage	Flooded Battery, AGM / Gel Battery	12.5	25	50
	LI	13.2	26.4	52.8
Refloat Voltage	Flooded Battery, AGM / Gel Battery	13.7	27.4	54.8
	LI	13.4	26.8	53.6
Float Voltage	Flooded Battery, AGM / Gel Battery	14.3	28.6	57.2
	LI	13.5	27	54
Charing Algorithm	3-Step(Flooded Battery, AGM/Gel Battery), 4-Step(LI)			
Solar Charging Mode				
INVERTER MODEL	1012/50A	2024/60A 3024/60A	4048/60A 5048/60A	4048/80A 5048/80A
Rated Power	600W	1500W	3000W	4000W
Solar Charging Current	50A	60A		80A
Efficiency	98.0% max.			
Max. PV Array Open Circuit Voltage	75Vdc max	100Vdc max	145Vdc	
PV Array MPPT Voltage Range	15~66Vdc	30~95Vdc	64~130Vdc	
Min battery voltage for PV charge	8.5Vdc	17Vdc	34Vdc	
Standby Power Consumption	2W			
Battery Voltage Accuracy	+/-0.3%			
PV Voltage Accuracy	+/-2V			
Charging Algorithm	3-Step(Flooded Battery, AGM/Gel Battery),4-Step(LI)			

Table 2 Inverter Mode Specifications

INVERTER MODEL	1012/50A	2024/60A 3024/60A	4048/60A 4048/80A 5048/60A 5048/80A
Rated Output Power	1KVA/0.8KW	2KVA/1.6KW 3KVA/2.4KW	4KVA/3.2KW 5KVA/4KW
Output Voltage Waveform	Pure Sine Wave		
Output Voltage Regulation	230Vac±5%		
Output Frequency	60Hz or 50Hz		
Peak Efficiency	90%		
Overload Protection	5s@ ≥150% load; 10s@110%~150% load		
Surge Capacity	2* rated power for 5 seconds		
Nominal DC Input Voltage	12Vdc	24Vdc	48Vdc
Cold Start Voltage	11.5Vdc	23.0Vdc	46.0Vdc
Low DC Warning Voltage			
@ load < 20%	11.0Vdc	22.0Vdc	44.0Vdc
@ 20% ≤ load < 50%	10.7Vdc	21.4Vdc	42.8Vdc
@ load ≥ 50%	10.1Vdc	20.2Vdc	40.4Vdc
Low DC Warning Return Voltage			
@ load < 20%	11.5Vdc	23.0Vdc	46.0Vdc
@ 20% ≤ load < 50%	11.2Vdc	22.4Vdc	44.8Vdc
@ load ≥ 50%	10.6Vdc	21.2Vdc	42.4Vdc
Low DC Cut-off Voltage			
@ load < 20%	10.5Vdc	21.0Vdc	42.0Vdc
@ 20% ≤ load < 50%	10.2Vdc	20.4Vdc	40.8Vdc
@ load ≥ 50%	9.6Vdc	19.2Vdc	38.4Vdc
High DC Recovery Voltage	14.5Vdc	29Vdc	58Vdc
High DC Cut-off Voltage	15.5Vdc	31Vdc	60Vdc
No Load Power Consumption	<15W	<25W	<50W
Saving Mode Power Consumption	<5W	<10W	<15W

*4KVA/5KVA only supports 230VAC system.

Install the unit by screwing three screws.

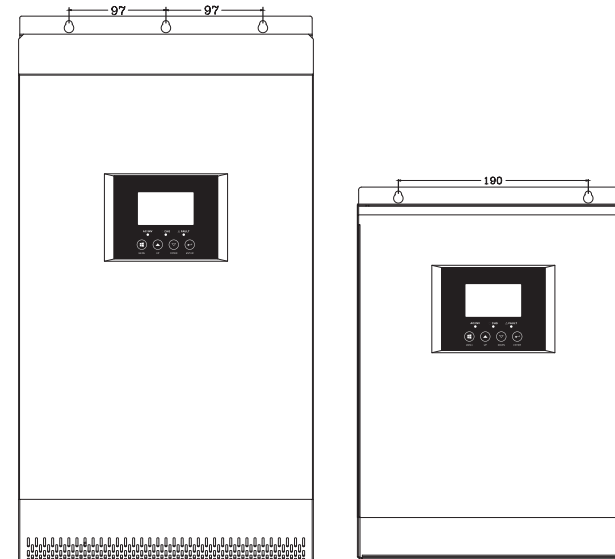

Battery Connection

CAUTION: For safety operation and regulation compliance, it's requested to install a separate DC over-current protector or disconnect device between battery and inverter. It may not be requested to have a disconnect device in some applications, however, it's still requested to have over-current protection installed. Please refer to typical amperage in below table as required fuse or breaker size.

Ring terminal:

WARNING! All wiring must be performed by a qualified personnel.

WARNING! It's very important for system safety and efficient operation to use appropriate cable for battery connection. To reduce risk of injury, please use the proper recommended cable and terminal size as below.

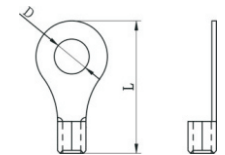

Recommended battery cable and terminal size:

Model	Typical Amperage	Battery Capacity	Wire Size	Ring Terminal			Torque Value
				Cable mm²	Dimensions		
					D (mm)	L (mm)	
1012 2024	66A	100AH	1*6AWG	14	6.4	29.2	2~ 3 Nm
		200AH	2*10AWG	8	6.4	23.8	
3024	100A	100AH	1*4AWG	22	6.4	33.2	2~ 3 Nm
		200AH	2*8AWG	14	6.4	29.2	
4048	66A	200AH	1*4AWG	22	6.4	33.2	2~ 3 Nm
			2*8AWG	14	6.4	29.2	
5048	87A	200AH	1*4AWG	22	6.4	33.2	2~ 3 Nm
			2*8AWG	14	6.4	29.2	

Please follow below steps to implement battery connection:

1. Assemble battery ring terminal based on recommended battery cable and terminal size.
2. Connect all battery packs as units requires. It's suggested to connect at least 100Ah capacity battery for 1-3KVA model and at least 200Ah capacity battery for 4KVA/5KVA model.

NOTE: Please only use sealed lead acid battery or sealed GEL/AGM lead-acid battery.

3. Insert the ring terminal of battery cable flatly into battery connector of inverter and make sure the bolts are tightened with torque of 2-3 Nm. Make sure polarity at both the battery and the inverter/charge is correctly connected and ring terminals are tightly screwed to the battery terminals.

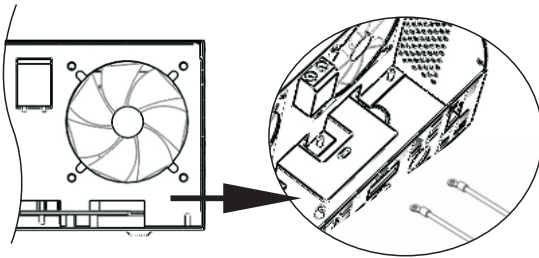

WARNING: Shock Hazard
Installation must be performed with care due to high battery voltage in series.

CAUTION!! Do not place anything between the flat part of the inverter terminal and the ring terminal. Otherwise, overheating may occur.
CAUTION!! Do not apply anti-oxidant substance on the terminals before terminals are connected tightly.
CAUTION!! Before making the final DC connection or closing DC breaker/disconnector, be sure positive (+) must be connected to positive (+) and negative (-) must be connected to negative (-).

SPECIFICATIONS

Table 1 Line Mode Specifications

INVERTER MODEL	1012/50A	2024/60A 3024/60A	4048/60A 4048/80A 5048/60A 5048/80A
Input Voltage Waveform	Sinusoidal (utility or generator)		
Nominal Input Voltage	230Vac		
Low Loss Voltage	90Vac±7V(SLO);170Vac±7V(FST) 186Vac±7V(APL)		
Low Loss Return Voltage	100Vac±7V(SLO);180Vac±7V(FST) 196Vac±7V(APL)		
High Loss Voltage	280Vac±7V(FST、SLO) 253Vac±7V(APL)		
High Loss Return Voltage	270Vac±7V(FST、SLO) 250Vac±7V(APL)		
Max AC Input Voltage	300Vac		
Nominal Input Frequency	50HZ/60HZ(Auto detection)		
Low Loss Frequency	40HZ±1HZ(FST、SLO) 47.5HZ±0.05HZ(APL)		
Low Loss Return Frequency	42HZ±1HZ(FST、SLO) 47.5HZ±0.05HZ(APL)		
High Loss Frequency	65HZ±1HZ(FST、SLO) 51.5HZ±0.05HZ(APL)		
High Loss Return Frequency	63HZ±1HZ(FST、SLO) 50.05HZ±0.05HZ(APL)		
Output Short Circuit Protection	Line mode: Circuit Breaker Battery mode: Electronic Circuits		
Efficiency (Line Mode)	>95% (Rated R load, battery full charged)		
Transfer Time	10ms typical (FST、APL) 20ms typical (SLO)		
Output power derating: When AC input voltage drops to 95V or 170V depending on models, the output power will be derated.	230Vac model: 		

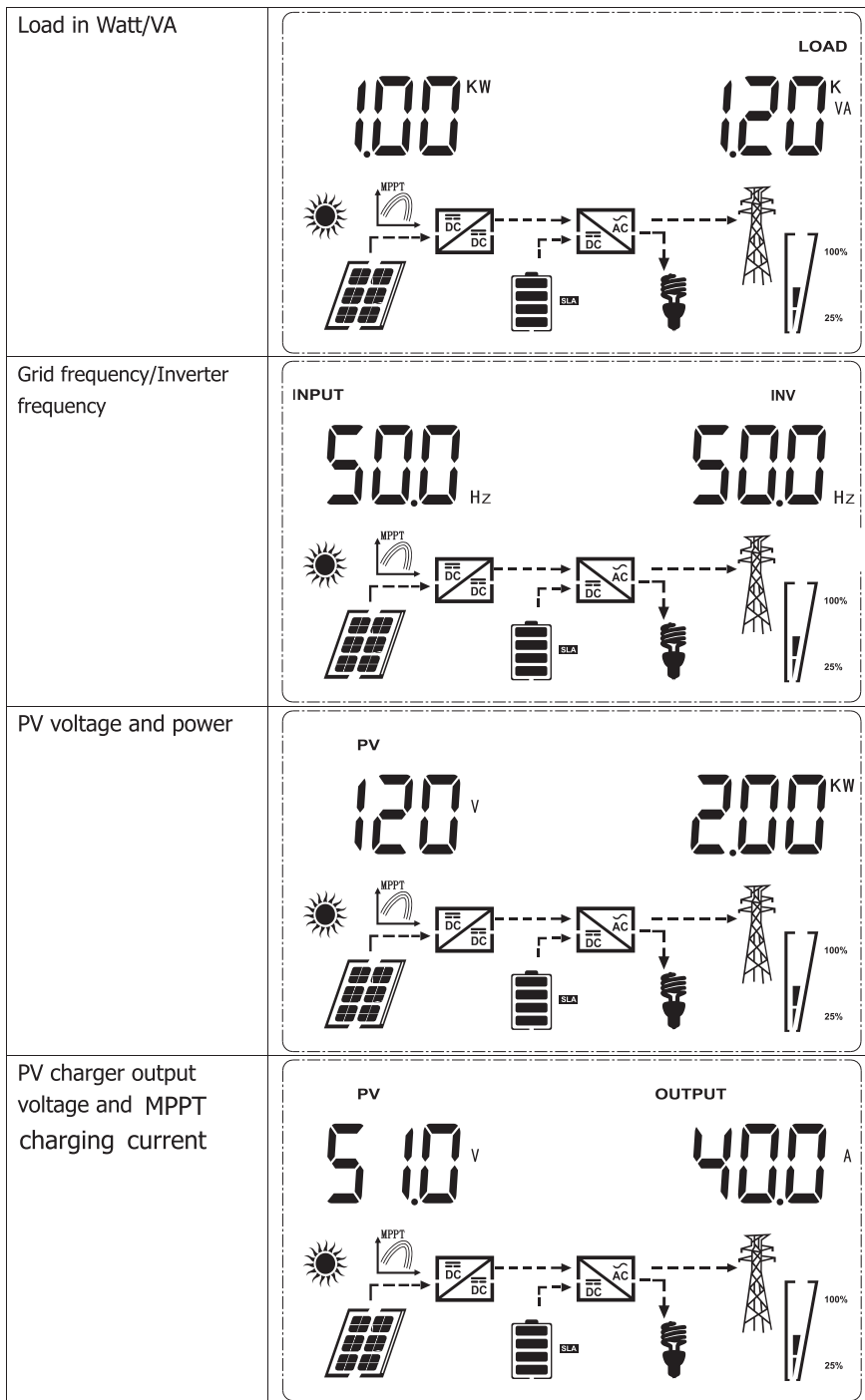

AC Input/Output Connection

CAUTION!! Before connecting to AC input power source, please install a separate AC breaker between inverter and AC input power source. This will ensure the inverter can be securely disconnected during maintenance and fully protected from over current of AC input. The recommended spec of AC breaker is 10A for 1KVA, 20A for 2KVA, 32A for 3KVA, 40A for 4KVA and 50A for 5KVA.

CAUTION!! There are two terminal blocks with “IN” and “OUT” markings. Please do NOT-misconnect input and output connectors.

WARNING! All wiring must be performed by a qualified personnel.

WARNING! It's very important for system safety and efficient operation to use appropriate cable for AC input connection. To reduce risk of injury, please use the proper recommended cable size as below.

Suggested cable requirement for AC wires

Model	Gauge	Torque Value
1KVA	16 AWG	0.5~ 0.6 Nm
2KVA	14 AWG	0.8~ 1.0 Nm
3KVA	12 AWG	1.2~ 1.6 Nm
4KVA	10 AWG	1.4~ 1.6Nm
5KVA	8 AWG	1.4~ 1.6Nm

Please follow below steps to implement AC input/output connection:

1. Before making AC input/output connection, be sure to open DC protector or disconnecter first.
2. Remove insulation sleeve 10mm for six conductors. And shorten phase L and neutral conductor N 3 mm.
3. Insert AC input wires according to polarities indicated on terminal block and tighten the terminal screws. Be sure to connect PE protective conductor (⊕) first.

⊕ → **Ground (yellow-green)**

L → **LINE (brown or black)**

N → **Neutral (blue)**

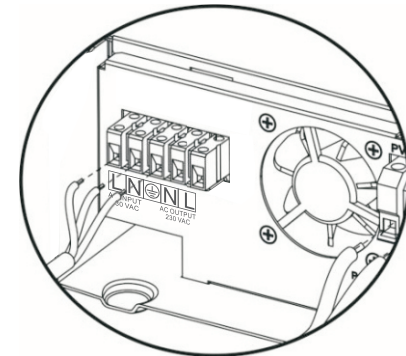

WARNING:

Be sure that AC power source is disconnected before attempting to hardwire it to the unit.

4. Then, insert AC output wires according to polarities indicated on terminal block and tighten terminal screws. Be sure to connect PE protective conductor (⊕) first.

⊕ → **Ground (yellow-green)**

L → **LINE (brown or black)**

N → **Neutral (blue)**

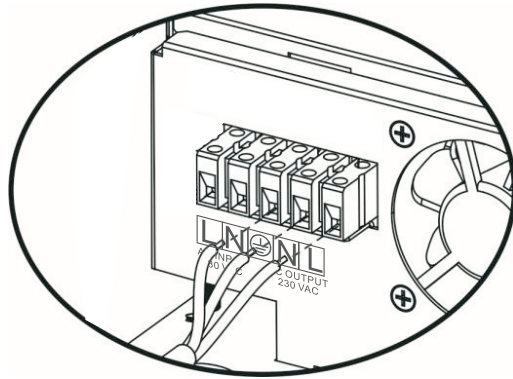

1KVA~5KVA

5. Make sure the wires are securely connected.

CAUTION: Important

Be sure to connect AC wires with correct polarity. If L and N wires are connected reversely, it may cause utility short-circuited when these inverters are worked in parallel operation.

CAUTION : Appliances such as air conditioner are required at least 2~3 minutes to restart because it's required to have enough time to balance refrigerant gas inside of circuits. If a power shortage occurs and recovers in a short time, it will cause damage to your connected appliances. To prevent this kind of damage, please check manufacturer of air conditioner if it's equipped with time-delay function before installation. Otherwise, this inverter/charger will trig overload fault and cut off output to protect your appliance but sometimes it still causes internal damage to the air conditioner.

PV Connection

CAUTION: Before connecting to PV modules, please install separately a DC circuit breaker between inverter and PV modules.

WARNING! All wiring must be performed by a qualified personnel.

WARNING! It's very important for system safety and efficient operation to use appropriate cable for PV module connection. To reduce risk of injury, please use the proper recommended cable size as below.

Model	Typical Amperage	Cable Size	Torque
1012/50A	50A	8 AWG	1.4~1.6Nm
2024/60A 3024/60A 4048/60A 5048/60A	60A	8 AWG	1.4~1.6Nm
4048/80A 5048/80A	80A	6 AWG	2.0~2.4Nm

Display Setting

The LCD display information will be switched in turns by pressing "UP" or "DOWN" key. The selectable information is switched as below order: battery voltage, battery current, inverter voltage, inverter current, grid voltage, grid current, load in Watt, load in VA, grid frequency, inverter frequency, PV voltage, MPPT charging power, MPPT charging output voltage, MPPT charging current.

Selectable information	LCD display
Battery voltage/ DC discharging current	
Inverter output voltage/Inverter output current	
Grid voltage/Grid current	

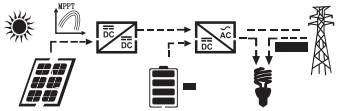
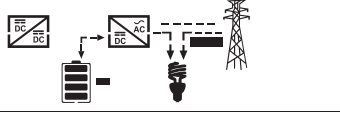
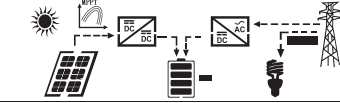
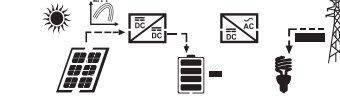
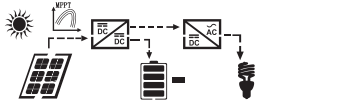
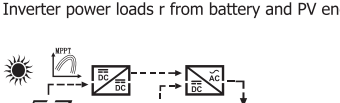
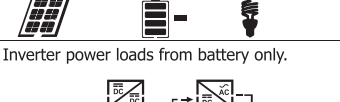
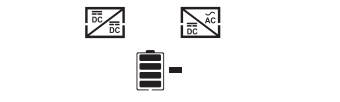
household appliances. Any excess power generated is not sold back to the grid, but stored in battery.		 <p>PV is off</p> 
Charge state	PV energy and grid can charge batteries.	
Bypass state	Error are caused by inside circuit error or external reasons such as over temperature, output short circuited and so on.	
Off-Grid state	The inverter will provide output power from battery and PV power.	<p>Inverter power loads from PV energy.</p>  <p>Inverter power loads r from battery and PV energy.</p>  <p>Inverter power loads from battery only.</p> 
Stop mode	The inverter stop working if you turn off the inverter by the soft key or error has occurred in the condition of no arid.	

PV Module Selection:

When selecting proper PV modules, please be sure to consider below parameters:

1. Open circuit Voltage (Voc) of PV modules not exceeds max. PV array open circuit voltage of inverter.
2. Open circuit Voltage (Voc) of PV modules should be higher than min. battery voltage.

Solar Charging Mode				
INVERTER MODEL	1012/50A	2024/60A 3024/60A	4048/60A 5048/60A	4048/80A 5048/80A
Max. PV Array Open Circuit Voltage	75Vdc max	100Vdc max	145Vdc	
PV Array MPPT Voltage Range	30~66Vdc	30~95Vdc	64-130Vdc	
Min . battery voltage for PV charge	8.5Vdc	17Vdc	34Vdc	

Please follow below steps to implement PV module connection:

1. Remove insulation sleeve 10 mm for positive and negative conductors.
2. Check correct polarity of connection cable from PV modules and PV input connectors. Then, connect positive pole (+) of connection cable to positive pole (+) of PV input connector. Connect negative pole (-) of connection cable to negative pole (-) of PV input connector.

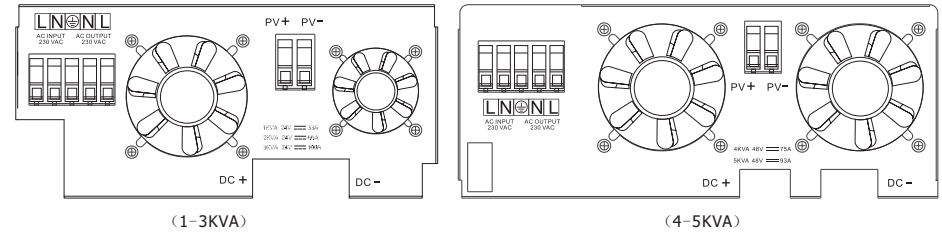
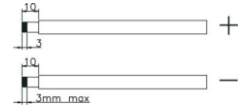

3. Make sure the wires are securely connected.

Final Assembly

After connecting all wirings, please put bottom cover back by screwing two screws as shown below.

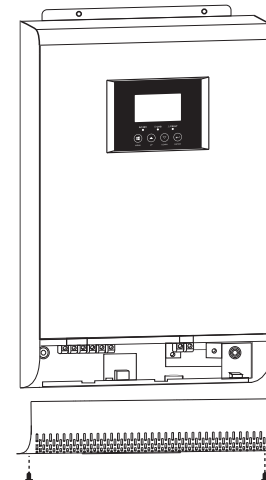

Communication Connection













Please use supplied communication cable to connect to inverter and PC. Insert bundled CD into a computer and follow on-screen instruction to install the monitoring software. For the detailed software operation, please check user manual of software inside of CD.

Dry Contact Signal

There is one dry contact (3A/250VAC) available on the rear panel. It could be used to deliver signal to external device when battery voltage reaches warning level.









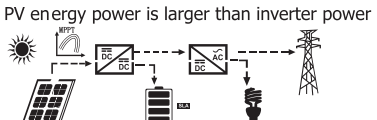
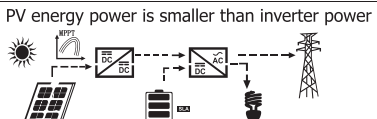
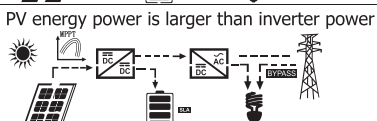
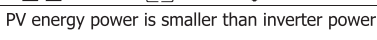





Unit Status	Condition		Dry contact port: 		
			NC & C	NO & C	
Power Off	Unit is off and no output is powered.		Close	Open	
	Output is powered from Utility.		Close	Open	
Power On	Output is powered from Battery or Solar.	Program 01 set as UPS	Battery voltage < Low DC warning voltage	Open	Close
			Battery voltage > Setting value in Program 09 or battery charging reaches floating stage	Close	Open
	Program 01 is set as PL, FL or FS, PO	Battery voltage < Setting value in Program 08	Open	Close	
		Battery voltage > Setting value in Program 09 or battery charging reaches floating stage	Close	Open	

Warning Indicator

Warning Code	Warning Event	Icon flashing
61	Fan is locked when inverter is on.	
62	Fan2 is locked when inverter is on.	
63	Battery is over-charged.	
64	Low battery	
67	Overload	
70	Output power derating	
72	Solar charger stops due to low battery.	
73	Solar charger stops due to high PV voltage.	
74	Solar charger stops due to over load.	
75	Solar charger over temperature	
76	PV charger communication error	
77	Parameter error	

Operating State Description

Operation state	Description	LCD display
Sell state Note: *Sell mode: The system generates electricity when the sun shines, supplying power to your home and sending any excess power back to the grid.	PV energy is sold back to grid.	
		
Match load state Note: DC power produced from your solar array is converted by the inverter into AC power, which is then sent to your main electrical panel to be used by your	PV energy is charger into the battery or converted by the inverter to the AC load.	
		

31	Solar charger battery voltage class error	[31] 
32	Solar charger current sensor error	[32] 
33	Solar charger current is uncontrollable	[33] 
41	Inverter grid voltage is low	[41] 
42	Inverter grid voltage is high	[42] 
43	Inverter grid under frequency	[43] 
44	Inverter grid over frequency	[44] 
51	Inverter over current protection error	[51] 
52	Inverter bus voltage is too low	[52] 
53	Inverter soft start failed	[53] 
55	Over DC voltage in AC output	[55] 
56	Battery connection is open	[56] 
57	Inverter control current sensor error	[57] 
58	Inverter output voltage is too low	[58] 

OPERATION

Power ON/OFF

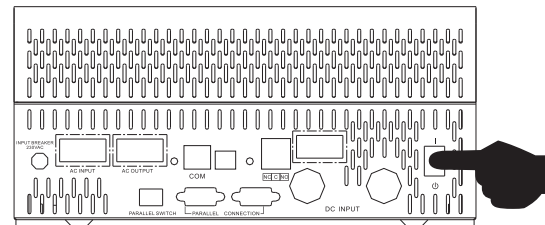

Once the unit has been properly installed and the batteries are connected well, simply press On/Off switch (located on the button of the case) to turn on the unit.

Operation and Display Panel

The operation and display panel, shown in below chart, is on the front panel of the inverter. It includes three indicators, four function keys and a LCD display, indicating the operating status and input/output power information.

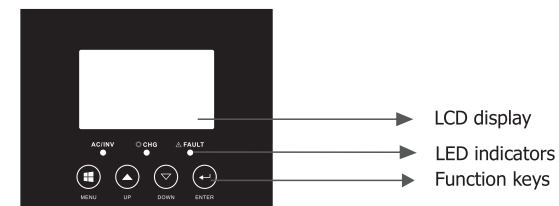

LED Indicator

LED Indicator		Messages
AC/ INV	Green	Solid On
		Flashing
● CHG	Yellow	Flashing
▲ FAULT	Red	Solid On
		Flashing

Function Keys

Function key	Description.
MENU	Enter or exit setting mode go to previous selection.
UP	Increase the setting data.
DOWN	Decrease the setting data.
ENTER	Confirm the selection in setting mode or go to next selection.

LCD Display Icons

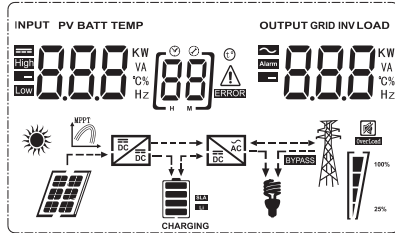

Icon	Function description	
Input Source Information and Output Information		
	Indicates the AC information	
	Indicates the DC information	
	Indicate input voltage, input frequency, PV voltage, battery voltage and charger current. Indicate output voltage, output frequency, load in VA, load in Watt and discharging current.	
Configuration Program and Fault Information		
	Indicates the setting programs.	
	Indicates the warning and fault codes. Warning: flashing with warning code. Fault: lighting with fault code.	
Battery Information		
	Indicates battery level by 0-24%, 25-49%, 50-74% and 75-100% in battery mode and charging status in line mode.	
In AC mode, it will present battery charging status.		
Status	Battery voltage	LCD Display
Constant Current mode / Constant Voltage mode	<2V/cell	4 bars will flash in turns.
	2 ~ 2.083V/cell	Bottom bar will be on and the other three bars will flash in turns.
	2.083 ~ 2.167V/cell	Bottom two bars will be on and the other two bars will flash in turns.
	> 2.167 V/cell	Bottom three bars will be on and the top bar will flash.
Batteries are fully charged .		4 bars will be on.

Fault Reference Code

Fault Code	Fault Cause	LCD Indication
01	Fan is locked when inverter is off	
02	Inverter transformer over temperature	
03	battery voltage is too high	
04	battery voltage is too low	
05	Output short circuited	
06	Inverter output voltage is high	
07	Overload time out	
08	Inverter bus voltage is too high	
09	Bus soft start failed	
11	Main relay failed	
21	Inverter output voltage sensor error	
22	Inverter grid voltage sensor error	
23	Inverter output current sensor error	
24	Inverter grid current sensor error	
25	Inverter load current sensor error	
26	Inverter grid over current error	
27	Inverter radiator over temperature	

		If selected, the display screen will stay at latest screen user finally switches.
Beeps while primary source is interrupted		Beeps off.
		Beeps on.
Alarm control		Alarm on.
		Alarm off.
Backlight control		Backlight on.
		Backlight off.
Record Fault code		Record enable.
		Record disable.

In battery mode, it will present battery capacity.				
Load Percentage	Battery Voltage	LCD Display		
Load > 50%	< 1.717V/cell			
	1.717V/cell ~ 1.8V/cell			
	1.8 ~ 1.883V/cell			
	> 1.883 V/cell			
50% > Load > 20%	< 1.817V/cell			
	1.817V/cell ~ 1.9V/cell			
	1.9 ~ 1.983V/cell			
	> 1.983			
Load < 20%	< 1.867V/cell			
	1.867V/cell ~ 1.95V/cell			
	1.95 ~ 2.033V/cell			
	> 2.033			
Load Information				
	Indicates overload.			
	Indicates the load level by 0-24%, 25-50%, 50-74% and 75-100%.			
	0%~25%	25%~50%	50%~75%	75%~100%
Mode Operation Information				
	Indicates unit connects to the mains.			
	Indicates unit connects to the PV panel.			
	Indicates load is supplied by utility power.			
	Indicates the solar charger circuit is working.			
	Indicates the DC/AC inverter circuit is working.			
Mute Operation				
	Indicates unit alarm is disabled.			

LCD Setting

After pressing and holding "MENU" button for 2 seconds, the unit will enter setting mode. Press "UP" or "DOWN" button to select setting programs. And then, press "ENTER" or "MENU" button to confirm the selection and exit.





Setting Programs:













Program	Selectable option	Description
	[5] INV	Select the setting of inverter.
	[5] CHA	Select the setting of solar charger.
	[5] S45	Select the setting of the system.
INVERTER		
Power use mode	[0] PL	PL: Solar energy provides power to the loads as first priority. If solar energy is not sufficient to power all connected loads, battery energy will supply power the loads at the same time. If the solar energy is large than the load and the battery voltage is high than the max voltage, the solar energy will sell to the grid.
	[0] FL	FL: the energy will never sell to the grid and the solar energy will full supply to the load.
	[0] FS	FS: the solar energy will sell to the grid as first priority.
	[0] UPS	UPS: the converter will charger the battery to full voltage combine with the solar charger controller.
	[0] PO	PO: the inverter will turn to offgrid state when the solar energy is enough.
Maximum charging current(DC)	[02] ^{60A(default)} 60 ^{120A(max)} 120	To configure total charging current for solar and utility chargers.(Max. charging current = utility charging current + solar charging current)
	[03] ^{30A (default)} 30 ^{60A(max)} 60	
Maximum Grid charging current(DC)	[03] ^{30A (default)} 30 ^{60A(max)} 60	
	[04] ^(default) 130 A	
Maximum discharging current (AC)	[04] ^(default) 130 A	Maximum discharging current: To configure Max Discharging current when the inverter is on Grid-tie state.

	40A models: 10.0A~40.0A(default) [4] 400 A	
Solar Charger absorb current	5.0A~30.0A(default) [48] 100 A	Set the absorb current of the Solar Charge Controller.(Refer to the Charging Curve)
Solar Charger voltage low DC cut-off	48V models: 34.0V~44.0V(default) [49] 340 V	If the battery voltage is lower than the set point, the Solar Charge Controller will close the output.
	24V models: 17.0V~22.0V(default) [49] 170 V	
Solar Charger high DC cut-off voltage	48V models: 58.0V~60.0V(default) [50] 600 V	If the battery voltage is higher than the set point, the Solar Charge Controller will close the output.
	24V models: 29.0V~30.0V(default) [50] 300 V	
SYSTEM		
Auto restart when overload occurs	[6] LFE	Restart enable.
	[6] LFD (default)	Restart disable.
Auto restart when over temperature occurs	[62] LTD	Restart disable.
	[62] LFE (default)	Restart enable.
Overload bypass: When enabled, the unit will transfer to line mode if overload occurs in battery mode	[63] BYE (default)	Bypass enable.
	[63] BYD	Bypass disable.
Auto turn page	[64] PFE (default)	If selected, the display screen will auto turn the display page.

CHARGER		
Solar Charger working Switch	(default) [4] ON	Open or close the Solar Charger Controller output.
	[4] OFF	
Battery type	(default) [42] Pb	Select the battery type.(Lead acid or Lithium)
	[42] L	
Battery AH	100AH~900AH [43] 200	Set the AH of the battery.
Solar Charger absorb voltage	48V models: 50.0V~54.0V(default) [44] 50.0 _v	Set the Absorb voltage.(Refer to the Charging Curve)
	24V models: 25.0V~27.0V(default) [44] 25.0 _v	
Solar Charger refloat voltage	48V models: 51.0V~55.0V(default) [45] 54.8 _v	Set the Refloat voltage.(Refer to the Charging Curve)
	24V models: 25.5V~27.5V(default) [45] 27.4 _v	
Solar Charger float voltage	48V models: 53.0V~58.0V(default) [46] 57.2 _v	Set the Float voltage.(Refer to the Charging Curve)
	24V models: 26.5V~29.0V(default) [46] 28.6 _v	
Solar Charger max current	60A models: 10.0A~60.0A(default) [47] 60.0 _A	Set the max output current of the Solar Charge Controller. (Refer to the Charging Curve)

AC input voltage range	Narrow (default) [09] FSt	If selected, acceptable AC input voltage range will be within 170-280VAC.
	Wide [09] SLo	If selected, acceptable AC input voltage range will be within 90-280VAC.
	APP-VDE4105 [09] APL	If selected, acceptable AC input voltage range will conform to VDE4105(184-253VAC).
Power saving(Search) mode enable/disable	Saving mode disable(default) [06] 5d5	If disabled, no matter connected load is low or high, the on/off status of inverter output will not be effected.
	Saving mode enable [06] 5e7	If enable, the inverter begins search mode if the AC load connected is pretty low or not detected. The inverter's "search" mode reduces stand-by energy consumption during no-load conditions.
Setting the min voltage point	45.0V~54.0V(default) [07] 48.0 _v	PL: when the battery voltage is lower than the setting point, the inverter will start recharging to battery.
		FL: when the battery voltage is lower than the setting point, the inverter will start recharging to battery.
		FS: when the battery voltage is lower than the setting point, the inverter will start recharging to battery.
		UPS: no use.
		PO: when the battery voltage is lower than the setting point, the inverter will start recharging to battery.
Setting the balance voltage point	48.0V~55.0V(default) [08] 53.0 _v	PL: when the battery voltage is higher than the setting point, the inverter will supply the power match the load, don't sell power back to grid. When the battery voltage is lower than the setting point, the inverter will stop discharging from battery.
		FL: when the battery voltage is higher than the setting point, the inverter will supply the power match the load, don't sell power back to grid. When the battery voltage is lower than the setting point, the inverter will stop discharging from battery.

		<p>FS: when the battery voltage is higher than the setting point, the inverter will discharge with max current. When the battery voltage is lower than the setting point, the inverter will stop discharging from battery.</p> <p>UPS: when the battery voltage is lower than the setting point, the inverter will start recharging the battery.</p> <p>PO: When the battery voltage is lower than the setting point, the inverter will back to the utility source. When the battery voltage is higher than the setting point, the inverter will stop charging to battery.</p>
Setting the max voltage point	<p>50.0V~58.0V(default)</p> 	<p>PL: In this mode, when the battery voltage is higher than the setting point, the inverter will sell power to the grid. When the battery voltage falls to the setting voltage below, the inverter will discharge match the load.</p> <p>FL: In this mode when the battery voltage is higher than the setting point, the inverter will discharge match the load.</p> <p>FS: In this mode when the battery voltage is higher than the setting point, the inverter will start selling power to the grid.</p> <p>UPS: In this mode when the battery voltage is higher than the setting point, the inverter will stop charging to battery.</p> <p>PO: When the battery voltage is higher than the setting point, the inverter will back to the offgrid state.</p>
Low DC cut-off voltage	<p>4/5KVA models: 40.0V~48.0V(default)</p>  <p>2/3KVA models: 20.0V~24.0V(default)</p> 	<p>48V model default setting: 42.0V Setting range is from 40.0V to 48.0V, Increment of each click is 0.1V. 24V model default setting: 21.0V Setting range is from 20.0V to 24.0V, Increment of each click is 0.1V.</p> <p>Low DC cut-off voltage will be fixed to setting value no matter what percentage of load is connected.</p>
Low DC recovery voltage	<p>4/5KVA models: 40.0V~50.0V(default)</p>  <p>2/3KVA models: 20.0V~25.0V(default)</p> 	<p>If the inverter is in the low voltage fault state of the battery, the battery voltage higher than the voltage, inverter will remove the battery low voltage fault.</p>

High DC cut-off voltage	<p>4/5KVA models: 58.0V~60.0V(default)</p>  <p>2/3KVA models: 29.0V~30.0V(default)</p> 	<p>48V model default setting: 60.0V Setting range is from,58.0V to 60.0V. Increment of each click is 0.1V High DC cut-off voltage will be fixed to setting value no matter what percentage of load is connected.</p> <p>24V model default setting: 30.0V Setting range is from,29.0V to 30.0V. Increment of each click is 0.1V High DC cut-off voltage will be fixed to setting value no matter what percentage of load is connected.</p>
Off-Grid enable	<p>On(default)</p>  <p>Off</p> 	<p>Turn on the inverter output when the grid is off.</p> <p>Shut down the inverter output when the grid is off.</p>
Grid-use enable	<p>Grid-use enable (default)</p>  <p>Grid-use disable</p> 	<p>Enable the inverter to connect to an AC input source.</p> <p>Disable the inverter to connect to an AC input source.</p>
Low battery voltage Protection mode	<p>(default)</p>  <p>User-Defined</p> 	<p>If "Usually-Defined" is selected, low DC cut-off voltage and low DC warning return voltage will follow the table 2 in page 28.</p> <p>If "User-Defined" is selected, low DC cut-off voltage and low DC warning return voltage can be set up in program 10 and 11.</p>
Output voltage	<p>(default)</p> 	<p>Set the output voltage amplitude. (220VAC-240VAC)</p>
Output frequency	<p>(default)</p>  <p>(default)</p> 	<p>50Hz.</p> <p>60Hz.</p>
Grid charge enable	<p>(default)</p>  <p>(default)</p> 	<p>Enable grid charge.</p> <p>Disable grid charge.</p>